

YJ-2001斯太尔王

- Application/适用于：斯太尔/Sitaier(可调/Adjustable)
- Color/颜色：红、黄、白/Red、Yellow、White
- LED's/数量：95
- Dimension/产品尺寸：488X138X31(mm)
- Mounting/安装：2个M8、4个M6螺栓/
2 M8、4 M6 screw bolts
- Voltage/电压：24V

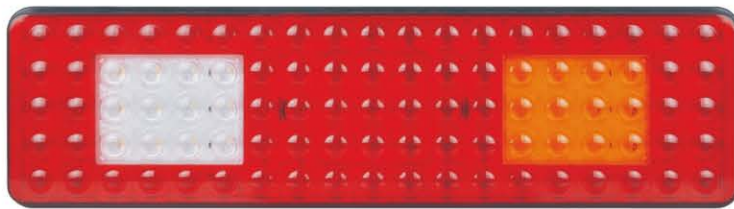
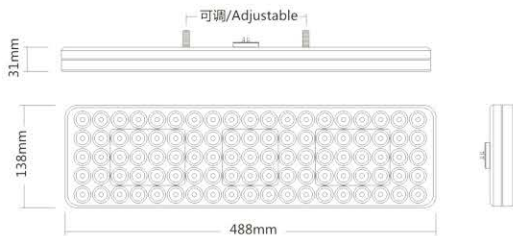

YJ-2002A巨能王

- Application/适用于：巨能王/FAW
- Color/颜色：红、黄、白/Red、Yellow、White
- LED's/数量：55
- Dimension/产品尺寸：410X150X57(mm)
- Mounting/安装：4个M6螺栓/ 4 M6 screw bolts
- Voltage/电压：24V
- Base of iron plate/铁板底座

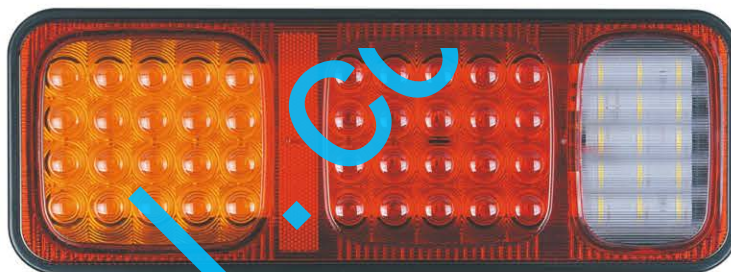
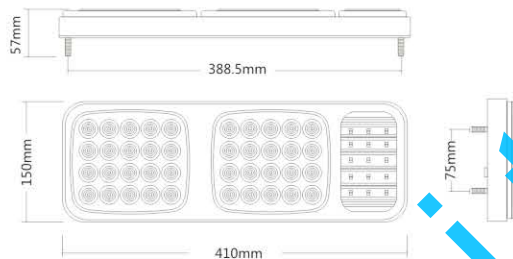

YJ-2026B (带牌照灯 With license plate lamp)

- Application/适用于：140-2(可调/Adjustable)
- Color/颜色：红、黄、白/Red、Yellow、White
- LED's/数量：55
- Dimension/产品尺寸：325X135X47(mm)
- Mounting/安装：2个M8螺栓/ 2 M8 screw bolts
- Voltage/电压：12V/ 24V
- Iron plate and bracket/铁板底座

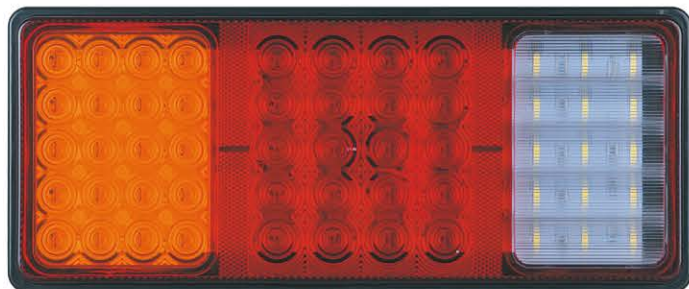
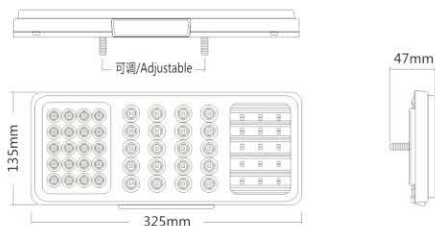

YJ-2003

- Application/适用于：140-2 (铁) /ISUZU NHR、NKR\NPR(Iron)
- Color/颜色：红、黄、白/Red、Yellow、White
- LED's/数量：44
- Dimension/产品尺寸：323X136X54(mm)
- Mounting/安装：2个M8螺栓/ 2 M8 screw bolts
- Voltage/电压：24V
- Plastic base/塑料底座

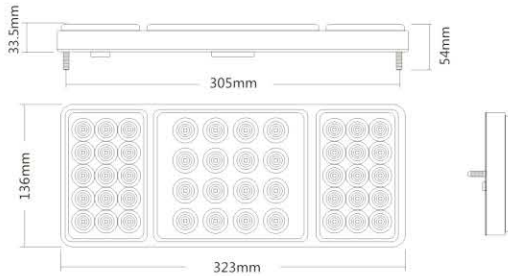

YJ-2003D

- Application/适用于：140-2 (铁) /ISUZU NHR、NKR\NPR(Iron)
- Color/颜色：红、黄、白/Red、Yellow、White
- LED's/数量：46
- Dimension/产品尺寸：325X136X53(mm)
- Mounting/安装：2个M8螺栓/ 2 M8 screw bolts
- Voltage/电压：24V
- Base of iron plate/铁板底座

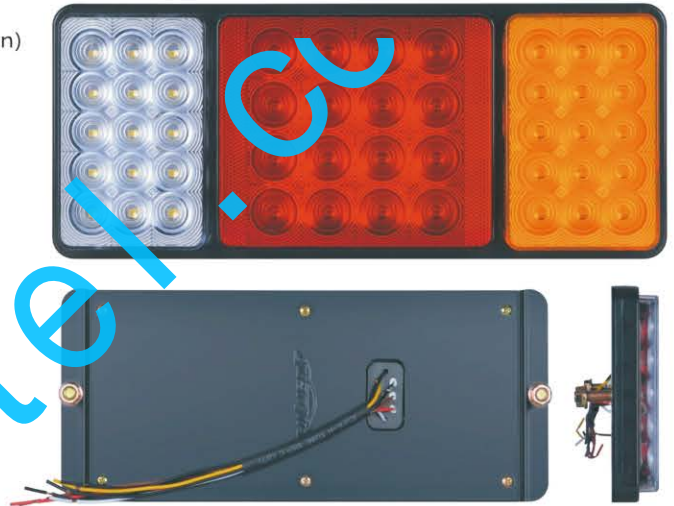
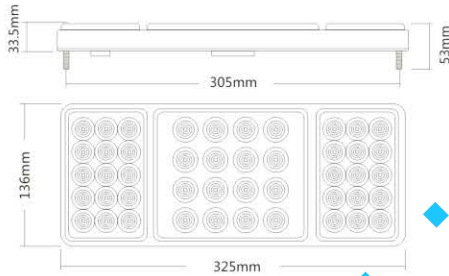

YJ-2007中集拖卡

- Application/适用于：中集拖卡 (铁制) Universal trailer
- Color/颜色：红、黄、白/Red、Yellow、White
- LED's/数量：60
- Dimension/产品尺寸：450X165X45(mm)
- Voltage/电压：24V
- Base of iron plate/铁板底座

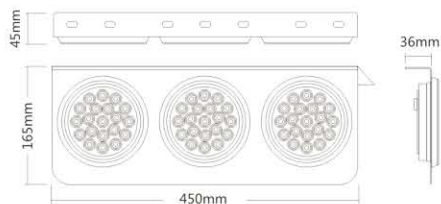

YJ-2009中集拖卡

- Application/适用于：中集拖卡/CIMC trailer
- Color/颜色：红、黄、白/Red、Yellow、White
- LED's/数量：144
- Dimension/产品尺寸：515X50X200(mm)
- Mounting/安装：7个螺丝孔/ 7 holes
- Voltage/电压：24V
- Base of iron plate/铁板底座

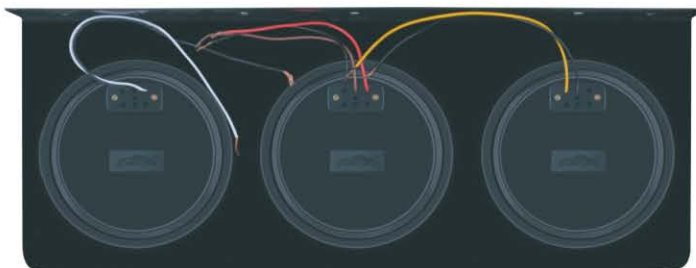
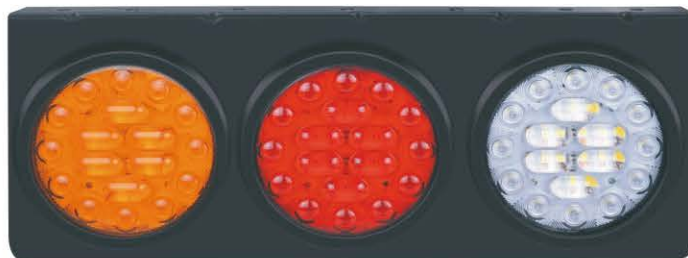
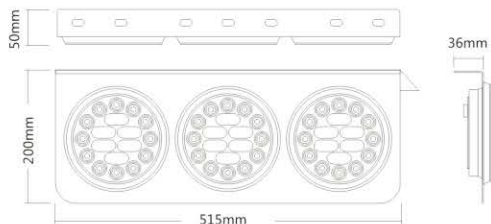

YJ-2006中集拖卡

- Application/适用于：中集拖卡/CIMC trailer
- Color/颜色：红、黄/Red、Yellow
- LED's/数量：40
- Dimension/产品尺寸：297X165X45(mm)
- Mounting/安装：5个螺丝孔/ 5 holes
- Voltage/电压：24V
- Base of iron plate/铁板底座

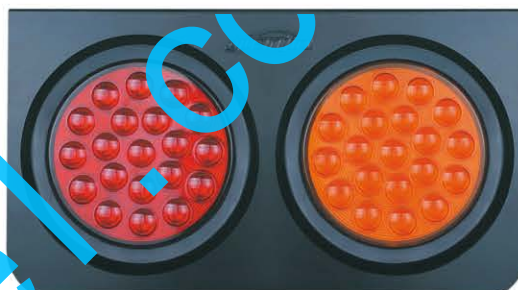

YJ-2005中集拖卡

- Application/适用于：中集拖卡/CIMC trailer
- Color/颜色：红、黄、白/Red、Yellow、White
- LED's/数量：20
- Dimension/产品尺寸：130X45(mm)
- Voltage/电压：24V

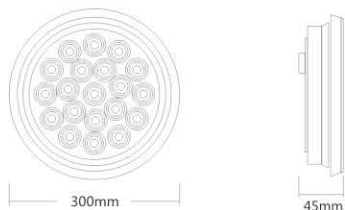

YJ-2008中集拖卡

- Application/适用于：中集拖卡（铁制）/CIMC trailer
- Color/颜色：红、黄、白/Red、Yellow、White
- LED's/数量：48
- Dimension/产品尺寸：163X31(mm)
- Voltage/电压：24V

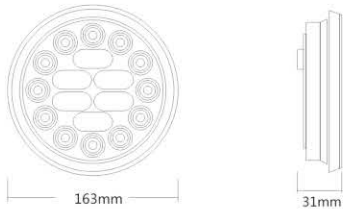

YJ-4010

- Vehicle sidelight/汽车照地边灯
- Application/适用于：通用型/Universal
- Color/颜色：红、黄、白、绿、蓝
Red、Yellow、White、Green、Blue
- Dimension/产品尺寸：126X105X19(mm)
- Mounting/安装：4个螺丝孔/4 holes
- Voltage/电压：12V/ 24V

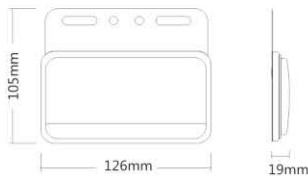

YJ-4012

- Vehicle sidelight/汽车照地边灯
- Application/适用于：通用型/Universal
- Color/颜色：红、黄、白、绿、蓝
Red、Yellow、White、Green、Blue
- Dimension/产品尺寸：150X70X49(mm)
- Mounting/安装：4个螺丝孔/4 holes
- Voltage/电压：24V

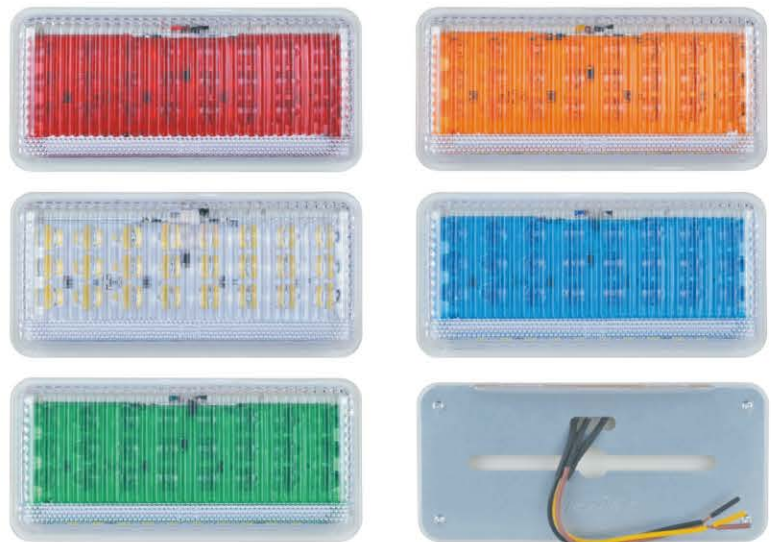

YJ-4003

- Vehicle sidelight/汽车照地边灯
- Application/适用于：通用型/Universal
- Color/颜色：红、黄、白、绿、蓝
- Red, Yellow, White, Green, Blue
- Dimension/产品尺寸：106X82X35(mm)
- Mounting/安装：2个螺丝孔/ 2 holes
- Voltage/电压：24V

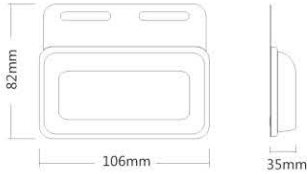

YJ-4011

- Vehicle sidelight/汽车照地边灯
- Application/适用于：通用型/Universal
- Color/颜色：红、黄、白、绿、蓝
- Red, Yellow, White, Green, Blue
- Dimension/产品尺寸：130X105X24(mm)
- Mounting/安装：4个螺丝孔/ 4 holes
- Voltage/电压：12V/ 24V

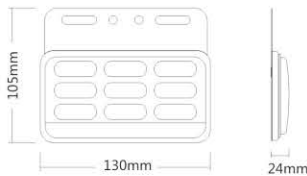

YJ-4013

- Vehicle sidelight/汽车照地边灯
- Application/适用于：通用型/Universal
- Color/颜色：红、蓝、黄、白、绿
- Red, Blue, Yellow, White, Green
- Dimension/产品尺寸：118X85X17(mm)
- Mounting/安装：4个螺丝孔/ 4 holes
- Voltage/电压：12V/ 24V

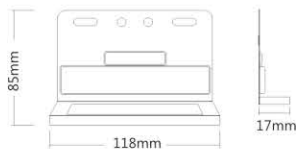

LED汽车大灯

高亮度

HIGH BRIGHTNESS

比原车增亮**3倍**

产品型号

H1、H3、H4、H7、H9、H13、
H15、9012、880/881、
H8/H11/H16、9005、9006、
9004、9007、D2、D4、5202

产品参数

30W 35W 40W 45W

产品电压

12V 24V



YJ-H1



YJ-H3



YJ-H4



YJ-H7



YJ-H11



YJ-9005



YJ-9006



ATM大插片式保险丝 ATM MAX AUTO PLUG-IN FUSES



ATM 20A



ATM 30A



ATM 40A



ATM 50A



ATM 60A



ATM 70A



ATM 80A



ATM 100A

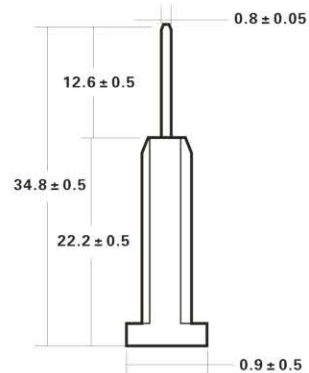
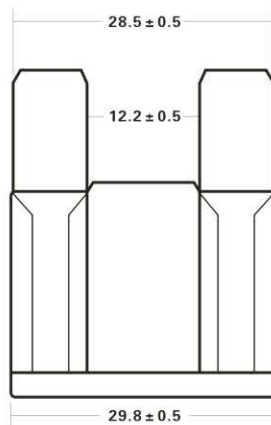

材质：
锌合金片；PC塑料

执行标准：
SAE J1888, QC/T420-2004

电气特点: ELECTRICAL CHARACTERISTICS:

额定 RATING	熔断时间	BLOWING TIME
110%	> 100小时	100hours Min
135%	60 - 1800秒	60 to 1800s
200%	2 - 60秒	2 to 60s
350%	20毫秒 - 7秒	20ms to 7s
600%	4毫秒 - 1秒	4ms to 1s

额定值 RATING

额定电流 Ampere Rating	额定电压 Ampere Voltage	颜色标准 Color
20	32	Yellow 黄色
30	32	Green 绿色
40	32	Dark Orange 深桔色
50	32	Red 红色
60	32	Blue 蓝色
70	32	Tan 茶色
80	32	Clear 透明色
100	32	Violet 紫罗兰色

ATC中插片式保险丝 ATC MEDIUM AUTO PLUG-IN FUSES

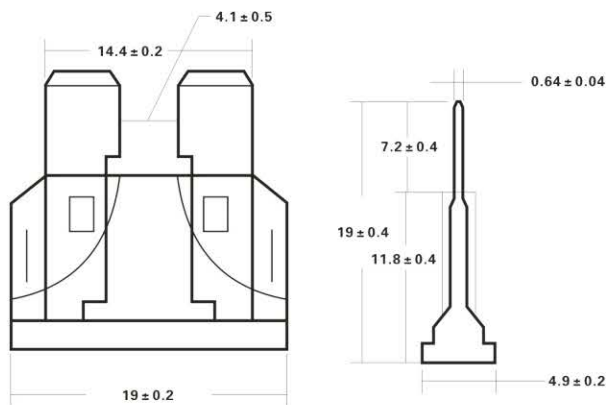
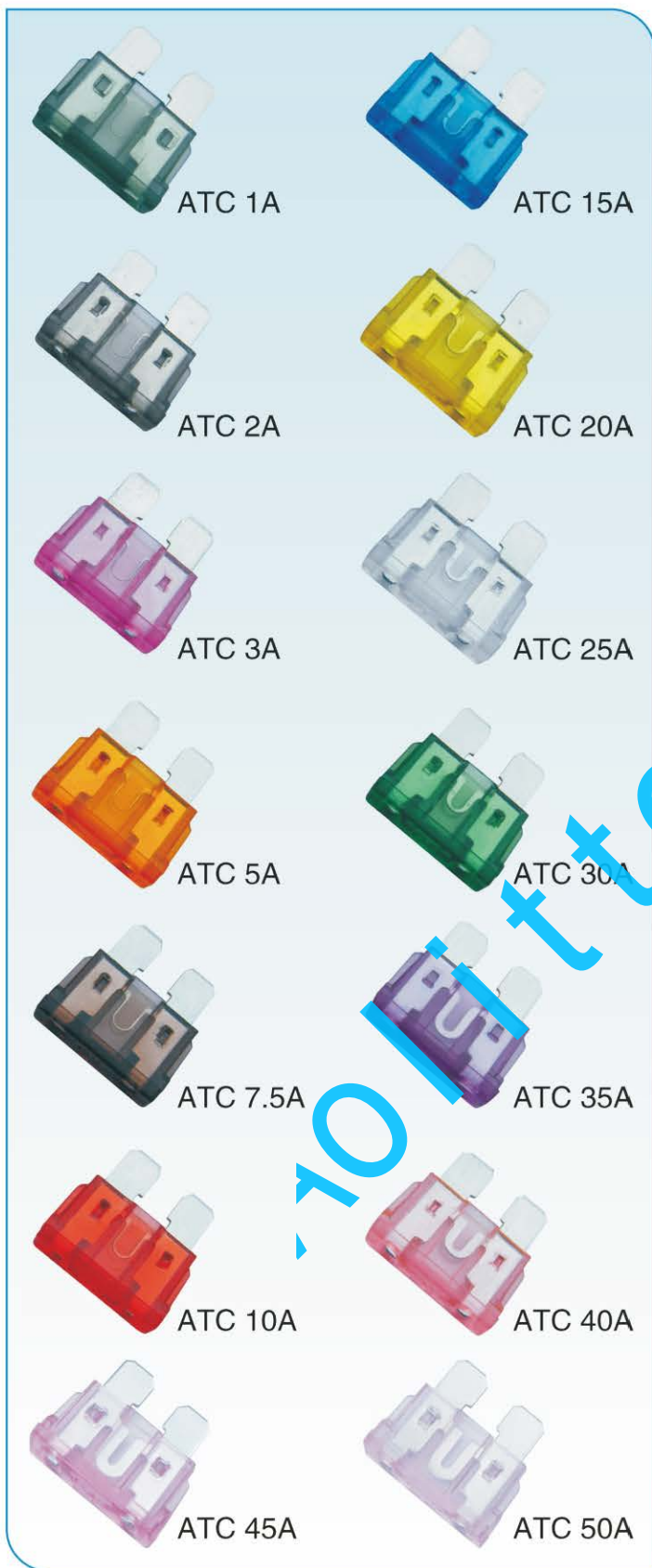

材质:
 锌合金片: PC 塑料壳

执行标准:
 SAE J2077, JASO D612, QC/T420-2004

电气特点: ELECTRICAL CHARACTERISTICS:

额定 RATING	熔断时间	BLOWING TIME
110%	>100小时	100hours Min
135%	0.75 - 1800秒	0.75 to 1800s
200%	0.15 - 5秒	0.15 to 5s
350%	0.04 - 0.5秒	0.04 to 0.5g
600%	0.02 - 0.1秒	0.02 to 0.1s

额定值 RATING

额定电流 Ampere Rating	额定电压 Ampere Voltage	颜色标准 Color
1	32	Pale Green 浅墨绿
2	32	Gray 灰
3	32	Violet 浅紫红
5	32	Orange 橙
7.5	32	Brown 咖啡色
10	32	Red 红
15	32	Blue 蓝
20	32	Yellow 黄
25	32	Natural 透明
30	32	Green 绿
35	32	Purple 紫
40	32	Light Red 浅红
45	32	Light Purple 浅紫色
50	32	Light Rose 浅玫红色

MINI小插片式保险丝 MINI AUTO PLUG-IN FUSES



MINI 1A



MINI 15A



MINI 2A



MINI 20A



MINI 3A



MINI 25A



MINI 5A

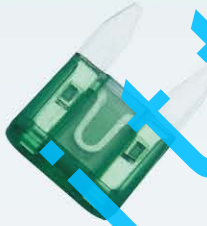

MINI 30A



MINI 7.5A



MINI 35A



MINI 10A



MINI 40A

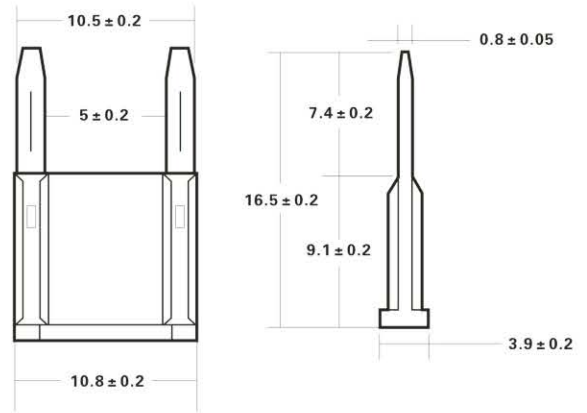

材质:
锌合金片: PC 塑料壳

执行标准:
SAE J2077, JASO D611, QC/T 20-2004

电气特点: ELECTRICAL CHARACTERISTICS:

额定 RATING	熔断时间	BLOWING TIME
110%	> 100小时	100hours Min
135%	0.75 - 1800秒	0.75 to 1800s
200%	0.15 - 5秒	0.15 to 5s
350%	0.04 - 0.5秒	0.04 to 0.5g
600%	0.02 - 0.1秒	0.02 to 0.1s

额定值 RATING

额定电流 Ampere Rating	额定电压 Ampere Voltage	颜色标准 Color	
1	32	Pale Green	浅墨绿
2	32	Gray	灰
3	32	Violet	浅紫红
5	32	Orange	橙
7.5	32	Brown	咖啡色
10	32	Red	红
15	32	Blue	蓝
20	32	Yellow	黄
25	32	Natural	透明
30	32	Green	绿
35	32	Purple	紫
40	32	Light Red	浅红

微型插片式保险丝 MINI AUTO PLUG-IN FUSES



电气特点: ELECTRICAL CHARACTERISTICS:

额定 RATING	熔断时间	BLOWING TIME
110%	> 100小时	100hours Min
135%	0.75 - 1800秒	0.75 to 1800s
200%	0.15 - 5秒	0.15 to 5s
350%	0.04 - 0.5秒	0.04 to 0.5g
600%	0.02 - 0.1秒	0.02 to 0.1s

材质:
锌合金片: PC 塑料壳

执行标准:
SAE J2077
JASO D612
QC/T420-2004

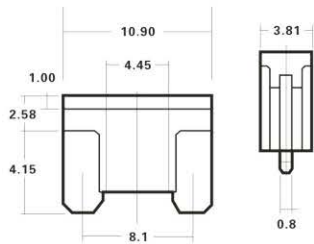

额定值 RATING

额定电流 Ampere Rating	额定电压 Ampere Voltage	颜色标准 Color
10	32	red 红色
15	32	blue 蓝色
20	32	yellow 黄色
25	32	white 白色
30	32	green 绿色

连接式保险丝 Connection Fuse



YJ-201(短内插)



YJ-202(长内插)



YJ-203(外插)



YJ-210(长、短脚平插)



YJ-211(迷你短内插)



YJ-212(迷你长内插)

螺栓式汽车总保险丝

SPIRAL AUTO MAIN FUSE

玻璃管状保险丝

GLASS TUBE FUSE



平板汽车总保险丝 AUTO FLAT FUSES

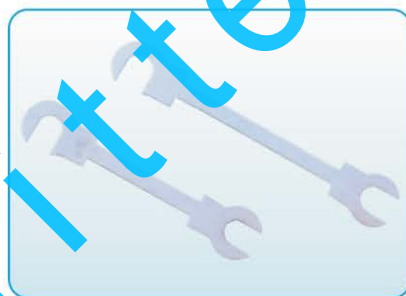

汽车大灯增强保护器(全新代)

BIG LAMP BRILLIANCE INTENSIFIER OF AUTO



2灯 4灯制正负极通用型

APPLICABLE FOR BOTH POSITIVE AND NEGATIVE POLE

型号Model: ZL-1202J

规格Specs: 12V 2/4灯12V 2/4Lamps

适用车型: 12V 2/4灯制H4灯头所有车系

Application for cars: 12V 2/4 H4 Lamps

型号Model: ZL-2404J

规格Specs: 24V 2/4灯24V 2/4Lamps

适用车型: 24V 2/4灯制H4灯头所有车系

Application for cars: Special for Isuzu

一箱数量quantity: 60套/箱(60sets/carton)

YJ 8105

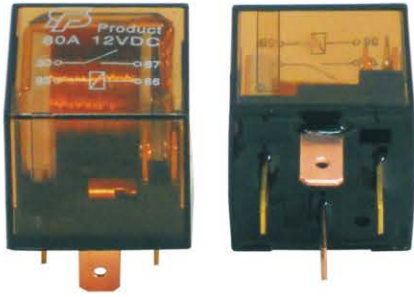

YJ 1912 UNIVERSAL

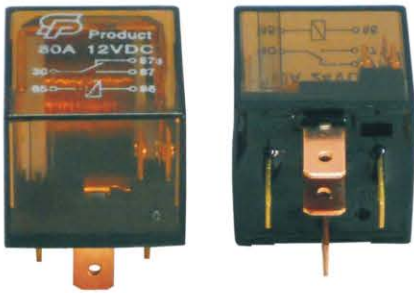

YJ 1914 UNIVERSAL

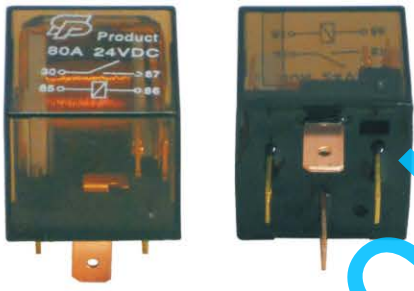

YJ 2912 UNIVERSAL

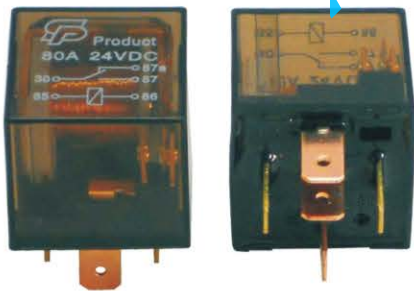

YJ 2914 UNIVERSAL

- 40/60A switching capacity of contacts;
- A set of normally open, normally closed, conversion, U contact form;
- Fast connecting type pin;
- Applicable to all types of circuit control;
- Physical Size: 28 × 28 × 25.5

Wiring diagram&Installation

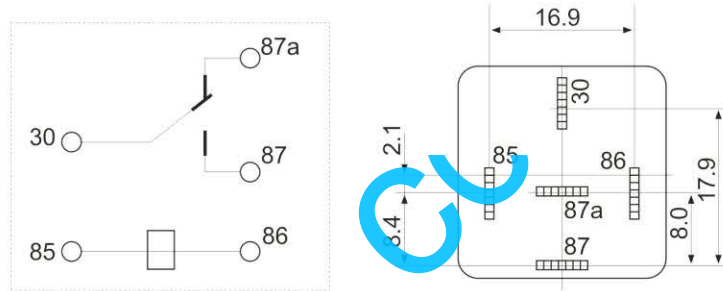

Contact Form:	1A/1B/1C
Terminal Material:	Silver Alloy
Rated Isolation Current:	80A
Contact Resistance:	50mΩ
Nominal Coil Voltage:	12V-24VDC
Coil Power Rating:	1.8W
Breakdown Voltage:	550V AC
Breakdown Voltage between contact and coil:	750V AC
Insulation Resistance:	100mΩ
Electrical Lifespan:	100,000 times
Mechanical Lifespan:	10,000,000 times
Rated Temperature:	-40°C~+85°C
Pull-in Time:	10ms
Release Time:	5ms
Terminal Configuration:	plug-in or welding
Physical Size:	28x28x25.5
Shell form:	flat housing, Iron or plastic support
Quantity:	(500pcs/carton)
Application: 12V(4 or 5pins), 24V(4 or 5pins) Universal	

YJ 8106



YJ 1912 WIDE FOOT



YJ 1914 WIDE FOOT



YJ 2912 WIDE FOOT



YJ 2914 WIDE FOOT

- 80A switching capacity of contacts;
- A set of normally open, normally closed, conversion, U contact form;
- Fast connecting type pin;
- Applicable to all types of circuit control;
- Physical Size: 28 × 28 × 25.5

Wiring diagram&Installation

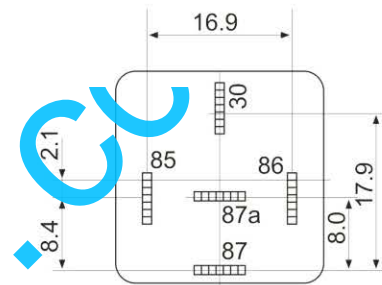
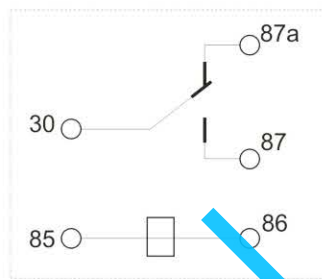

Contact form:	1A/1C
Terminal Material:	Silver Alloy
Rated Isolation Current:	80A
Contact Resistance:	50mΩ
Nominal Coil Voltage:	12V-24VDC
Coil Power Rating:	1.8W
Breakdown Voltage:	550V AC
Breakdown Voltage between contact and coil:	750V AC
Insulation Resistance:	100mΩ
Electrical Lifespan:	100,000 times
Mechanical Lifespan:	10,000,000 times
Rated Temperature:	-40°C~+85°C
Pull-in Time:	10ms
Release Time:	5ms
Terminal Configuration:	Plug type
Physical Size:	28x28x25.5
Shell form:	flat housing, Iron or plastic support

Application: Air-conditioning, Kama

YJ 7110

12V 1912VIOLET

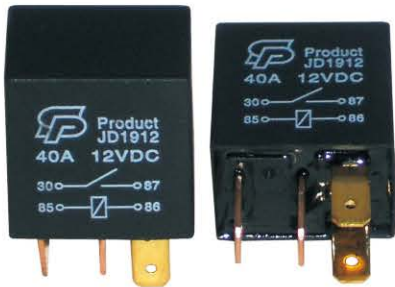

12V 1914VIOLET

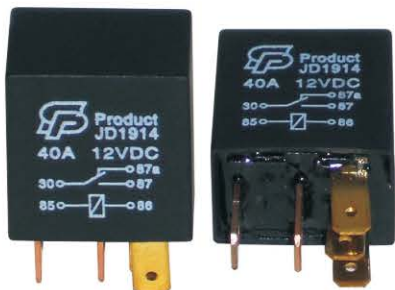

24V 2912VIOLET

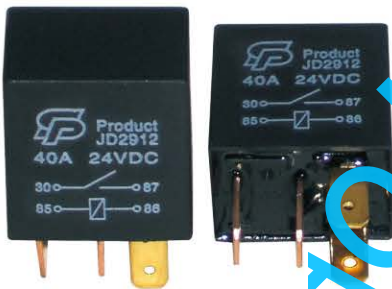

24V 2914VIOLET

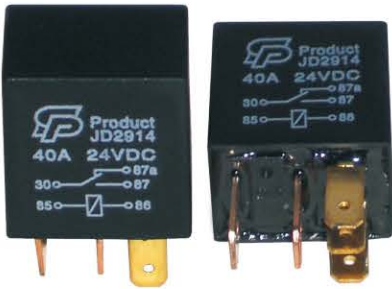

- 40/30A switching capacity of contacts;
- A group of normally open contact form;
- Fast connecting type pin;
- Applicable to all types of circuit control;
- Physical Size: 23 × 15.5 × 22

Wiring diagram&Installation

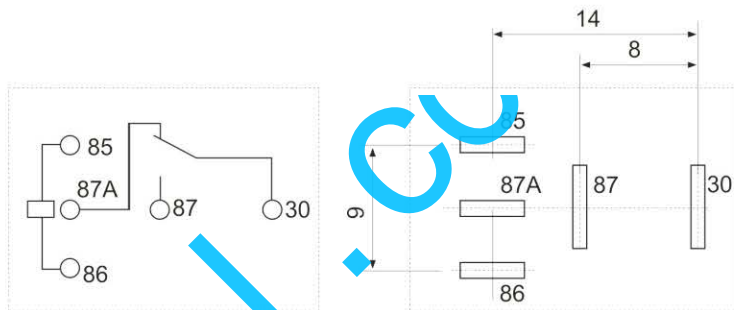

Contact Form:	1A/1B/1C
Terminal Material:	Silver Alloy
Rated Isolation Current:	30A
Contact Resistance:	50mΩ
Nominal Coil Voltage:	12V-24VDC
Coil Power Rating:	1.6W
Breakdown Voltage:	550V AC
Breakdown Voltage between contact and coil:	750V AC
Insulation Resistance:	100mΩ
Electrical Lifespan:	100,000 times
Mechanical Lifespan:	10,000,000 times
Rated Temperature:	-40℃~+85℃
Pull-in Time:	10ms
Release Time:	5ms
Terminal Configuration:	Plug type
Physical Size:	23x15.5x22
Shell form:	flat housing

Application: 12V(4 or 5pins), 24V(4 or 5pins) Universal

YJ 7114

- 40/30A switching capacity of contacts;
- A group of normally open contact form;
- Fast connecting type pin;
- Applicable to all types of circuit control;
- Physical Size: 28 × 23 × 41.5



Wiring diagram&Installation

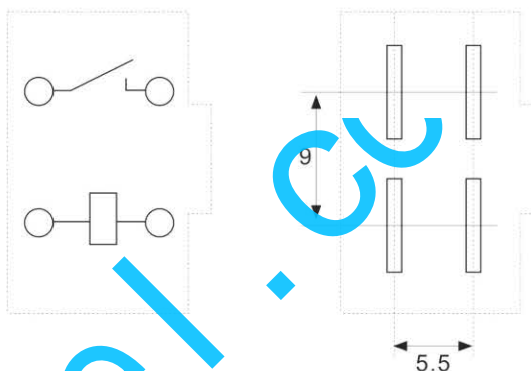

Contact Form:	1A
Terminal Material:	Silver Alloy
Rated Isolation Current:	40A
Contact Resistance:	50mΩ
Nominal Coil Voltage:	12V–24VDC
Coil Power Rating:	1.6W
Breakdown Voltage:	550V AC
Breakdown Voltage between contact and coil	750V AC
Insulation Resistance:	100mΩ
Electrical Lifespan:	100,000 times
Mechanical Lifespan:	10,000,000 times
Rated Temperature:	–40°C~+85°C
Pull-in Time:	10ms
Release Time:	5ms
Terminal Configuration:	Plug type
Physical Size:	28x23x41.5
Application: Air-conditioning	

YJ 7101

12V 1912

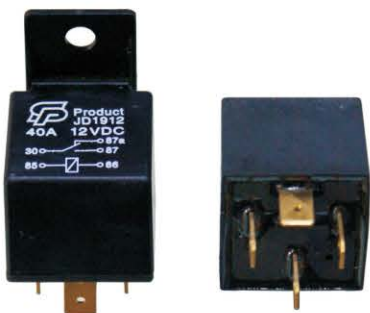

12V 1914

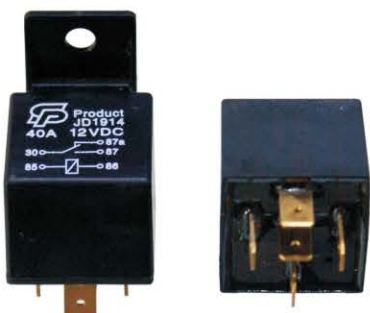

24V 2912

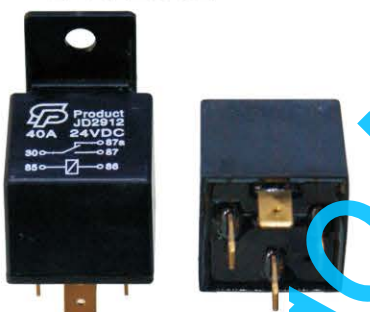

24V 2914

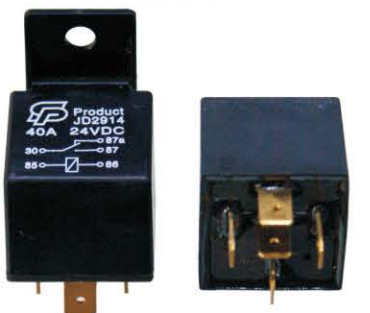

- 40/30A switching capacity of contacts;
- A group of normally open contact form;
- Fast connecting type pin;
- Applicable to all types of circuit control;
- Physical Size: 28 × 28 × 25.5

Wiring diagram&Installation

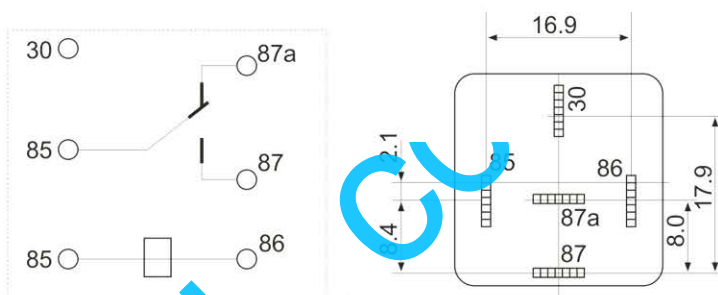

Contact Form:	1A/1B/1C
Terminal Material:	Silver Alloy
Rated Isolation Current:	40A
Contact Resistance:	50mΩ
Nominal Coil Voltage:	12V-24VDC
Coil Power Rating:	1.8W
Breakdown Voltage:	550V AC
Breakdown Voltage between contact and coil:	750V AC
Insulation Resistance:	100mΩ
Electrical Lifespan:	100,000 times
Mechanical Lifespan:	10,000,000 times
Rated Temperature:	-40°C~+85°C
Pull-in Time:	10ms
Release Time:	5ms
Terminal Configuration:	plug-in or welding
Physical Size:	28x28x25.5
Shell form:	flat housing, Iron or plastic support
Quantity:	(600pcs/carton)

Application: 12V(4 or 5pins), 24V(4 or 5pins) Universal

YJ 7104

12V 1912

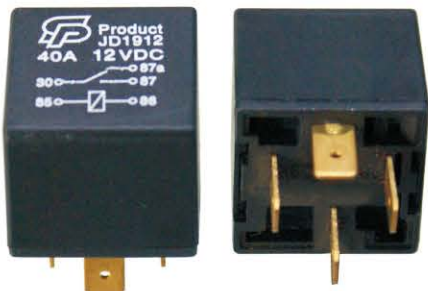

12V 1914



24V 2912



24V 2914

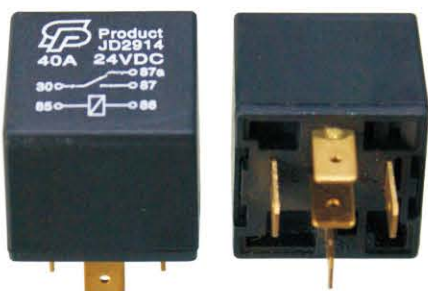

- 40/30A switching capacity of contacts;
- A group of normally open contact form;
- Fast connecting type pin;
- Applicable to all types of circuit control;
- Physical Size: 28 × 28 × 25.5

Wiring diagram&Installation

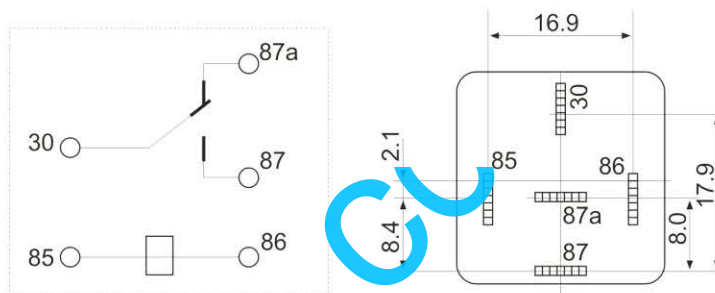

Contact Form:	1A/1B/1C
Terminal Material:	Silver Alloy
Rated Isolation Current:	60A
Contact Resistance:	50mΩ
Nominal Coil Voltage:	12V-24VDC
Coil Power Rating:	1.8W
Breakdown Voltage:	550V AC
Breakdown Voltage between contact and coil:	750V AC
Insulation Resistance:	100mΩ
Electrical Lifespan:	100,000 times
Mechanical Lifespan:	10,000,000 times
Rated Temperature:	-40°C~+85°C
Pull-in Time:	10ms
Release Time:	5ms
Terminal Configuration:	plug-in or welding
Physical Size:	28x28x25.5
Shell form:	flat housing, Iron or plastic support
Quantity:	(500pcs/carton)
Application: 12V(4 or 5pins), 24V(4 or 5pins) Universal	

YJ 9101

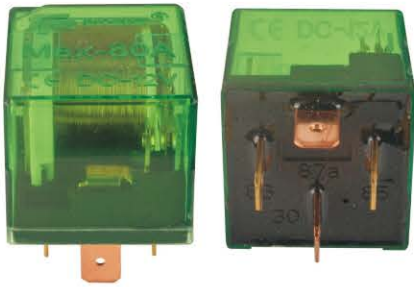

YJ 1912

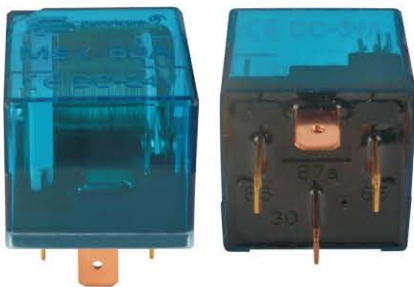

YJ 2912

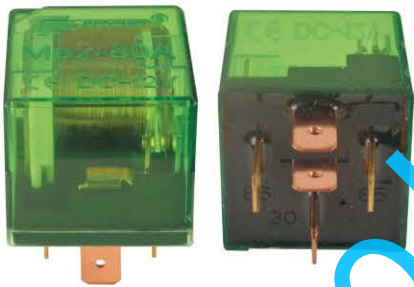

YJ 1914

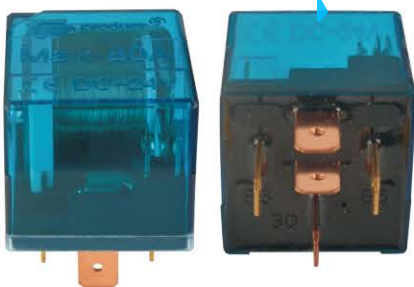

YJ 2914

- 40/60A switching capacity of contacts;
- A set of normally open, normally closed, conversion, U contact form;
- Fast connecting type pin;
- Applicable to all types of circuit control;
- Physical Size: 28 × 28 × 25.5

Wiring diagram&Installation

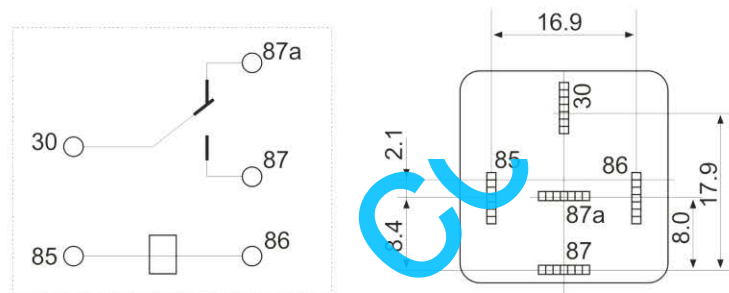

Contact Form:	1A/1B/1C
Terminal Material:	Silver Alloy
Rated Isolation Current:	80A
Contact Resistance:	50mΩ
Nominal Coil Voltage:	12V~24VDC
Coil Power Rating:	1.8W
Breakdown Voltage:	550V AC
Breakdown Voltage between contact and coil	750V AC
Insulation Resistance:	100mΩ
Electrical Lifespan:	100,000 times
Mechanical Lifespan:	10,000,000 times
Rated Temperature:	-40℃~+85℃
Pull-in Time:	10ms
Release Time:	5ms
Terminal Configuration:	plug-in or welding
Physical Size:	28x28x25.5
Shell form:	flat housing, Iron or plastic support
Quantity:	500只/箱(500pcs/carton)
Application: 12V(4 or 5pins), 24V(4 or 5pins) Universal	

YJ 7112

24V 四插(东风天龙)



24V 五插(东风天龙)



- 40/30A switching capacity of contacts;
- A group of normally open contact form;
- Fast connecting type pin;
- Applicable to all types of circuit control;
- Physical Size: 23 × 15.5 × 22

Wiring diagram&Installation

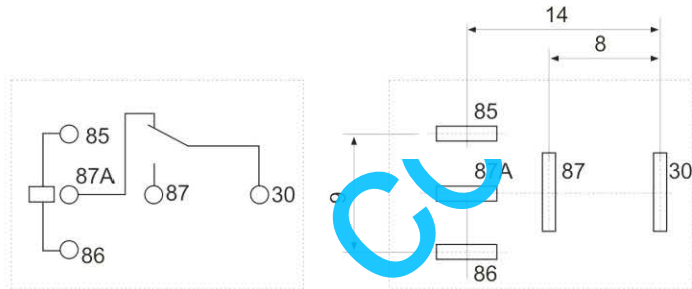

YJ 7113



12V、24V 四插
(带保险继电器)

- 40/60A switching capacity of contacts;
- A set of normally open, normally closed, conversion, U contact form;
- Fast connecting type pin;
- Applicable to all types of circuit control;
- Physical Size: 28 × 28 × 25.5

Wiring diagram&Installation

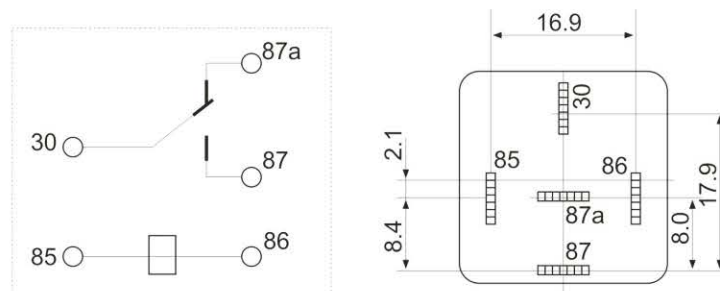

YJ SG7315



12V / 24V

YJ SG7316



12V / 24V

Contact Form:	1A
Terminal Material:	Silver Alloy
Rated Isolation Current:	40A
Contact Resistance:	50mΩ
Nominal Coil Voltage:	12V-24VDC
Coil Power Rating:	1.6W
Breakdown Voltage:	550V AC
Breakdown Voltage between contact and coil:	750V AC
Insulation Resistance:	100mΩ
Electrical Lifespan:	100,000 times
Mechanical Lifespan:	10,000,000 times
Rated Temperature:	-40°C~+85°C
Pull-in Time:	10ms
Release Time:	5ms
Terminal Configuration:	Plug type
Shell form:	Transparent shell, Black shell, with iron backrest
Application:	Flasher



YJ 8107-1

12V 起动继电器
Jd134 12V EQ153

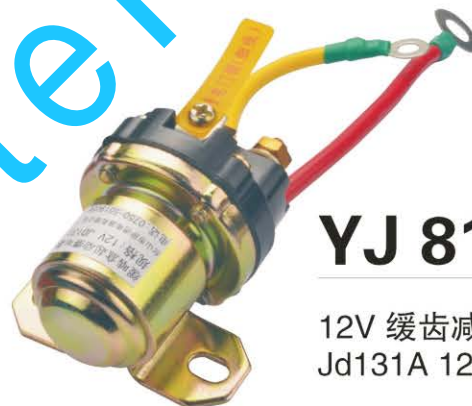

YJ 8108-1

12V 缓齿减速起动继电器
Jd131A 12V EQ151



YJ 8107-2

24V 起动继电器
Jd234 24V EQ153



YJ 8108-2

24V 缓齿减速起动继电器
Jd231A 24V Eq151

Be fit for left-hand and right-hand drive models

适合左右驾车型



通用型无骨雨刷

Soft wiper blade-Universal type

The universal soft wiper blade is suitable for more than 95% of models

通用型无骨雨刷适用于95%以上的车型。

The wiper arm functions:
雨刷臂的功能

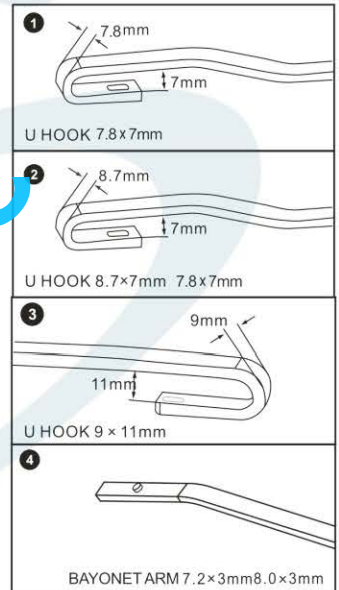

Apply to specific wiper arms as below:

- 1.U-HOOK wiper blade arms:7.8x7mm
- 2.U-HOOK wiper blade arms:8.7x7mm
- 3.U-HOOK wiper blade arms:9x11mm
- 4.Bayonet wiper blade arms:7.2x3mm/8.0x3mm

可安装主要雨刮臂:

- 1.普通型: 7.8x7mm勾式雨刮臂
- 2.普通型: 8.7x7mm勾式雨刮臂
- 3.普通型: 9x11mm勾式雨刮臂
- 4.卡口式雨刮臂: 7.2x3mm/8.0x3mm

Optional sizes: 可提供尺寸

14"	15"	16"	17"	18"	19"	20"	21"	22"	23"	24"	25"	26"	27"	28"
350mm	375mm	400mm	425mm	450mm	475mm	500mm	525mm	550mm	575mm	600mm	625mm	650mm	675mm	700mm
✓		✓	✓	✓	✓	✓	✓	✓	✓	✓		✓		✓

Be fit for left-hand and right-hand drive models
 适合左右驾车型



通用型无骨雨刷 Soft wiper blade-Universal type

The universal soft wiper blade is suitable for more than 95% of models
 通用型无骨雨刷适用于95%以上的车型。



The wiper arm functions:
 雨刷臂的功能

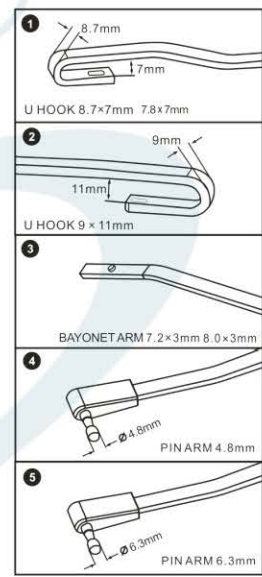

Apply to specific wiper arms as below:

- 1.U-HOOK wiper blade arms:8.7x7mm
- 2.U-HOOK wiper blade arms:9x11mm
- 3.Bayonet wiper blade arms:7.2x3mm/8.0x3mm
- 4.Side Pin wiper blade arms:Ø4.8mm
- 5.Side Pin wiper blade arms:Ø6.3mm

可安装主要雨刮臂:

- 1.普通型: 8.7x7mm勾式雨刮臂
- 2.普通型: 9x11mm勾式雨刮臂
- 3.卡口式雨刷臂: 7.2x3mm/8.0x3mm
- 4.侧式雨刮臂: Ø4.8mm
- 5.侧式雨刮臂: Ø6.3mm

Optional sizes: 可提供尺寸

14"	15"	16"	17"	18"	19"	20"	21"	22"	23"	24"	25"	26"	27"	28"
350mm	375mm	400mm	425mm	450mm	475mm	500mm	525mm	550mm	575mm	600mm	625mm	650mm	675mm	700mm
✓		✓	✓	✓	✓	✓	✓	✓	✓	✓		✓		✓

Be fit for left-hand and right-hand drive models
 适合左右驾车型



多功能无骨雨刷

Multifunctional frameless wiper

our multi-adapter wiper blade can fit for more than 98% car type.

多模适配器雨刮器适用于98%以上车型。

The wiper arm functions:
 雨刷臂的功能

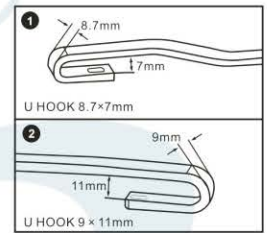

Apply to specific wiper arms as below:

- 1.U-HOOK wiper blade arms:8.7x7mm
- 2.U-HOOK wiper blade arms:9 x 11mm

可安装主要雨刮臂:

- 1.普通型: 8.7x7mm勾式雨刮臂
- 2.普通型: 9 x 11mm勾式雨刮臂

Optional sizes: 可提供尺寸

14"	15"	16"	17"	18"	19"	20"	21"	22"	23"	24"	25"	26"	27"	28"
350mm	375mm	400mm	425mm	450mm	475mm	500mm	525mm	550mm	575mm	600mm	625mm	650mm	675mm	700mm
✓		✓	✓	✓	✓	✓	✓	✓		✓	✓	✓		

Be fit for left-hand and right-hand drive models
适合左右驾车型



通用型有骨雨刷

Soft wiper blade-Universal type

Our Universal type soft wiper blade can fit for more than 95% car types.

通用型有骨雨刷适用于95%以上的车型。

The wiper arm functions:
雨刷臂的功能

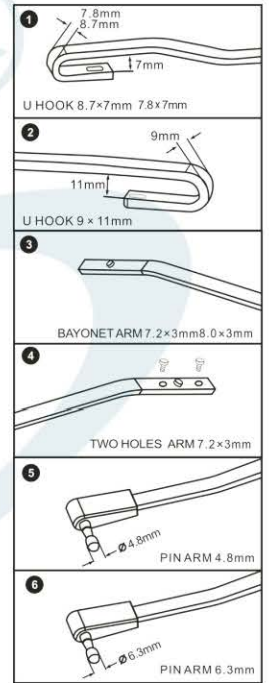

Apply to specific wiper arms as below:

- 1.U-HOOK wiper blade arms:8.7x7mm 7.8x7mm
- 2..U-HOOK wiper blade arms:9x11mm
- 3.Bayonet wiper blade arms:7.2x3mm/8.0x3mm
- 4.Scwrew wiper blade arms:7.2x3mm
- 5.Side Pin wiper blade arms:Ø4.8mm
- 6.Side Pin wiper blade arms:Ø6.3mm

可安装主要雨刮臂:

- 1.普通型: 8.7x7mm 7.8x7mm 勾式雨刮臂
- 2.普通型: 9x11mm 勾式雨刮臂
- 3.卡口式雨刮臂: 7.2x3mm/8.0x3mm
- 4.锁螺丝雨刮臂 7.2x3mm
- 5.侧式雨刮臂: Ø4.8mm
- 6.侧式雨刮臂: Ø6.3mm

Optional sizes: 可提供尺寸

14"	15"	16"	17"	18"	19"	20"	21"	22"	23"	24"	25"	26"	27"	28"
350mm	375mm	400mm	425mm	450mm	475mm	500mm	525mm	550mm	575mm	600mm	625mm	650mm	675mm	700mm
✓		✓	✓	✓	✓	✓	✓	✓		✓		✓		✓

Be fit for left-hand and right-hand drive models

适合左右驾车型



通用型雨刷

Soft wiper blade-Universal type

Our Universal type soft wiper blade can fit for more than 95% car types.

通用型雨刷可以容纳超过95%类型。

The wiper arm functions:
雨刷臂的功能

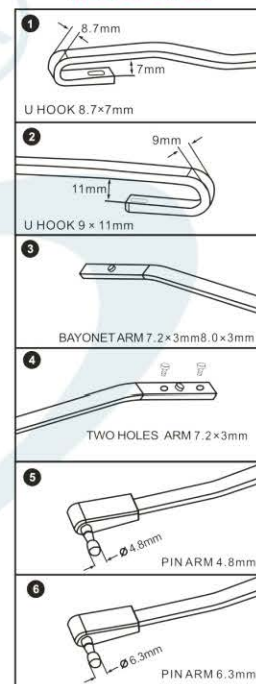

Apply to specific wiper arms as below:

1. U-Hook 8.7x7mm
2. U-Hook 9x11mm
3. Bayonet 7.2x3mm / 8.0x3mm
4. Screw 7.2x3mm
5. Side pin 4.8mm
6. Side pin 6.3mm

Optional sizes: 可提供尺寸

14"	15"	16"	17"	18"	19"	20"	21"	22"	23"	24"	25"	26"	27"	28"
350mm	375mm	400mm	425mm	450mm	475mm	500mm	525mm	550mm	575mm	600mm	625mm	650mm	675mm	700mm
✓		✓	✓	✓	✓	✓	✓	✓	✓	✓		✓		✓

Be fit for left-hand and right-hand drive models

适合左右驾车型



多功能无骨雨刷

Multifunctional frameless wiper

our multi-adapter wiper blade can fit for more than 98% car type.

多模适配器雨刮器适用于98%以上车型。



1. HAKEN 8.7x7mm 7.8x7mm	1.1	1.2	1.3
2. HAKEN 8x11mm	2.1	2.2	2.3
3. TOP LOCK 15mm	3.1	3.2	3.3
4. TOP LOCK 15mm	4.1	4.2	4.3
5. BAYONET 16mm	5.1	5.2	5.3
6. BAYONET 19mm	6.1	6.2	6.3
7. SPECIAL HAKEN 6mm	7.1	7.2	7.3
8. SIDE PIN \varnothing 5x22mm	8.1	8.2	8.3
9. SIDE PIN \varnothing 5x17mm	9.1	9.2	9.3
10. SIDE PIN 5mm	10.1	10.2	10.3
11. BAYONET 9x4mm	11.1	11.2	11.3
12. BAYONET 7.2x3mm 8x3mm	12.1	12.2	12.3

Befitting wiper arms:

A. U-Hook 8.7x7mm / 7.8x7mm, Bayonet 7.2x2.8mm

B1. Pinch Tab 15mm

B2. Push Button 16mm / 15mm

B3. Bayonet 9x4mm

C. Side Pin 5x17mm / 5x22mm

D. Side pin 4.8mm / 4.3mm / 6mm

E. Slide 15mm

F. Special Pinch tab 6mm

Optional sizes: 可提供尺寸

14"	15"	16"	17"	18"	19"	20"	21"	22"	23"	24"	25"	26"	27"	28"
350mm	375mm	400mm	425mm	450mm	475mm	500mm	525mm	550mm	575mm	600mm	625mm	650mm	675mm	700mm
✓	✓	✓	✓	✓	✓	✓	✓	✓	✓	✓	✓	✓	✓	✓

Be fit for left-hand and right-hand drive models
适合左右驾车型



宽口有骨雨刮24"(德龙) Wide mouth iron wiper 24 "(Delong)



The wiper arm functions:

雨刷臂的功能

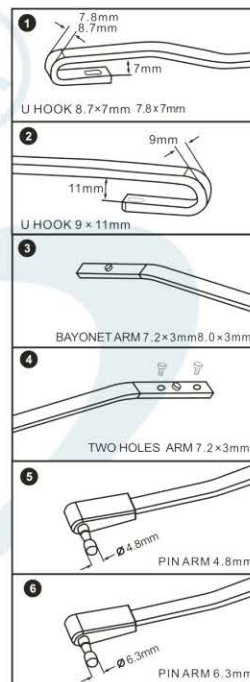

Apply to specific wiper arms as below:

1. U-HOOK wiper blade arms: 12x35mm

可安装主要雨刮臂:

1. 普通型: 12x35mm 勾式雨刮臂

Be fit for left-hand and right-hand drive models
适合左右驾车型



宽口有骨雨刮26"(德龙、杰狮) Wide mouth iron wiper 26 "(Delong、Jieshi)



The wiper arm functions:
雨刷臂的功能

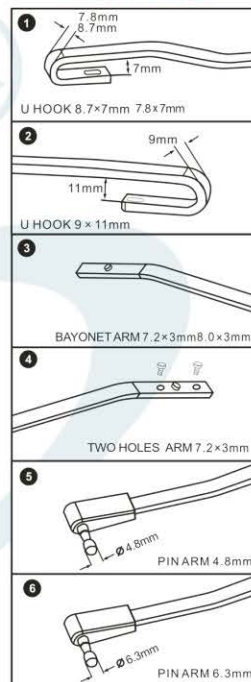

Apply to specific wiper arms as below:

1.U-HOOK wiper blade arms:12x35mm

可安装主要雨刮臂:

1.普通型: 12x35mm 勾式雨刮臂

Be fit for left-hand and right-hand drive models
适合左右驾车型



宽口有骨雨刮28" (豪沃、奥德赛、霸王)

Wide mouth iron wiper 28 "(HOWO, Odyssey, Overlord)



The wiper arm functions:
雨刷臂的功能

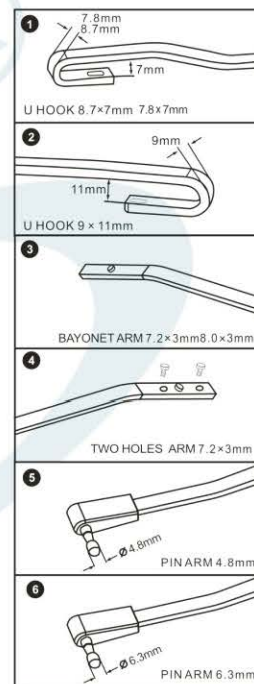

Apply to specific wiper arms as below:

1. U-HOOK wiper blade arms: 12x35mm

可安装主要雨刮臂:

1. 普通型: 12x35mm 勾式雨刮臂

Be fit for left-hand and right-hand drive models
适合左右驾车型



J6专用雨刮28"

J6 special wiper 28 "



The wiper arm functions:

雨刷臂的功能

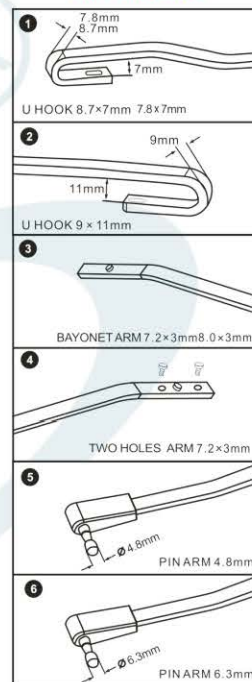

Apply to specific wiper arms as below:

1.U-HOOK wiper blade arms:10x25mm

可安装主要雨刮臂:

1.普通型: 10x25mm 勾式雨刮臂

汽车接插件系列 Automobile Connector Series



H1/H3直角陶瓷灯座
H1/H3 bend angle
ceramic lampholders



H1/H3弯角陶瓷灯座
H1/H3 bend angle
ceramic lampholders



喇叭插头线
Horn plug wire

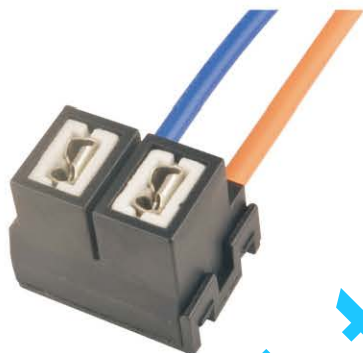

H7弯角陶瓷灯座
H7 bend angle
ceramic lampholders



H7直角陶瓷灯座
H7 bend angle
ceramic lampholders

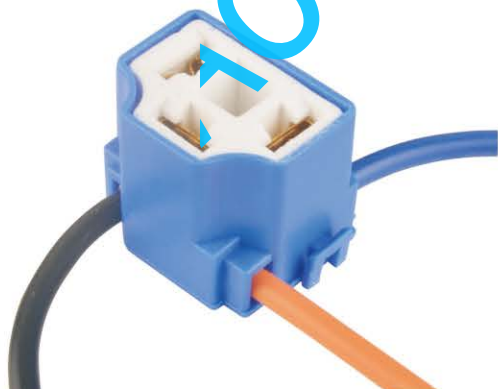

H4弯角陶瓷灯座
H4 bend angle
ceramic lampholders

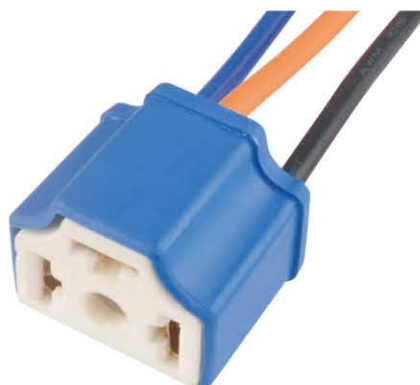

H4直角陶瓷灯座
H4 bend angle
ceramic lampholders



陶瓷保险盒
Ceramic Protective Box

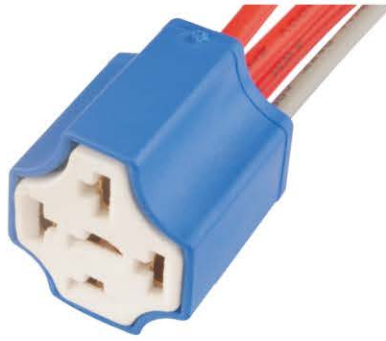

继电器陶瓷插座
relay ceramic socket



继电器陶瓷插座
relay ceramic socket

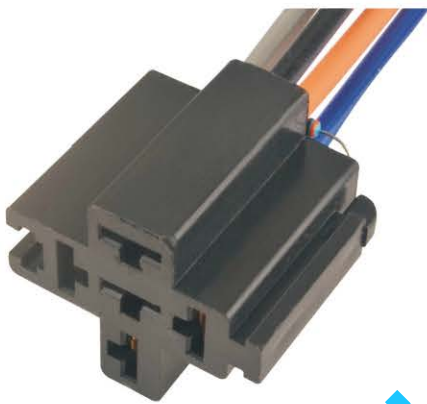

继电器胶木插座
bakelite socket relay

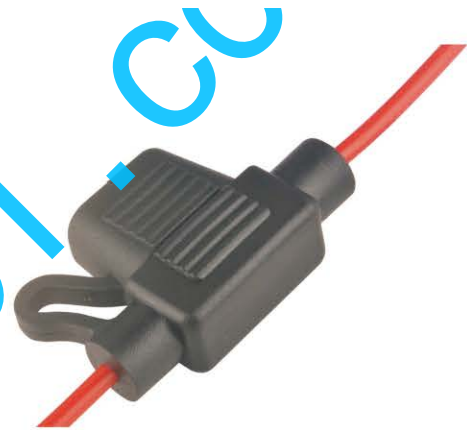

迷你防水保险盒
Mini Waterproof fuse box



中型防水保险盒
ATC Waterproof fuse box



大型防水保险盒
ATM Waterproof fuse box