

Fuses

您的电路保护专家

YOUR CIRCUIT PROTECTION EXPERT

东莞市奥力特电子科技有限公司

企业简介 东莞市奥力特电子科技有限公司



创新 / 赢势 / 赢天下

目录

1

企业介绍
企业进程

2

营销网络
旗下事业部

3

业务介绍
产品介绍

4

应用领域
工厂环境

5

企业资质
合作伙伴



Fuse Selection Steps / 選用保險絲的基本步驟

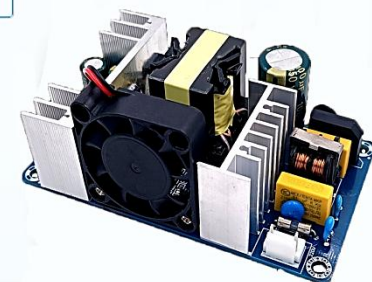

企业简介 Business introduction



AOLITTEL/奥力特成立于2001年,我们专注于生产各种电流保险丝,贴片保险丝及熔断器其它电路保护元器件的企业。产品广泛应用于消费电子、移动设备、家用电器、照明电器、电源供应器及适配器、通讯设备、太阳能电场装置以及工业电力控制设备等领域。

目前拥有现代化的生产厂房3000多平方米,拥有各种先进的自动化加工组装和检测设备。每月3000万只的生产能力,作为全国熔断器标准化技术委员会小型熔断器成员单位之一,参与起草并制订小型熔断器的国家标准及行业标准,自主拥有独立的科研及技术开发创新能力。公司已通过了ISO9001国际质量体系认证和IATF16949体系认证。

并获得了UL/cUL/VDE/TUV/CCC/CQC/PSE/KC等各国安规认证,符合RoHS环保指令和REACH法规的要求。经过十余年的发展,公司拥有了一批经验丰富技术熟练的研发、生产、品质管理团队,产品质量稳定性始终处于行业领先地位。(生产基地设为大岭山和松山湖)

公司以“客户至上、精诚合作、开拓创新、持续提升”作为企业的核心文化,倾力打造满足用户需求的优质精品,以成为”业界优秀电路保护生产商”为经营目标。



企业进程 DEVELOPMENT

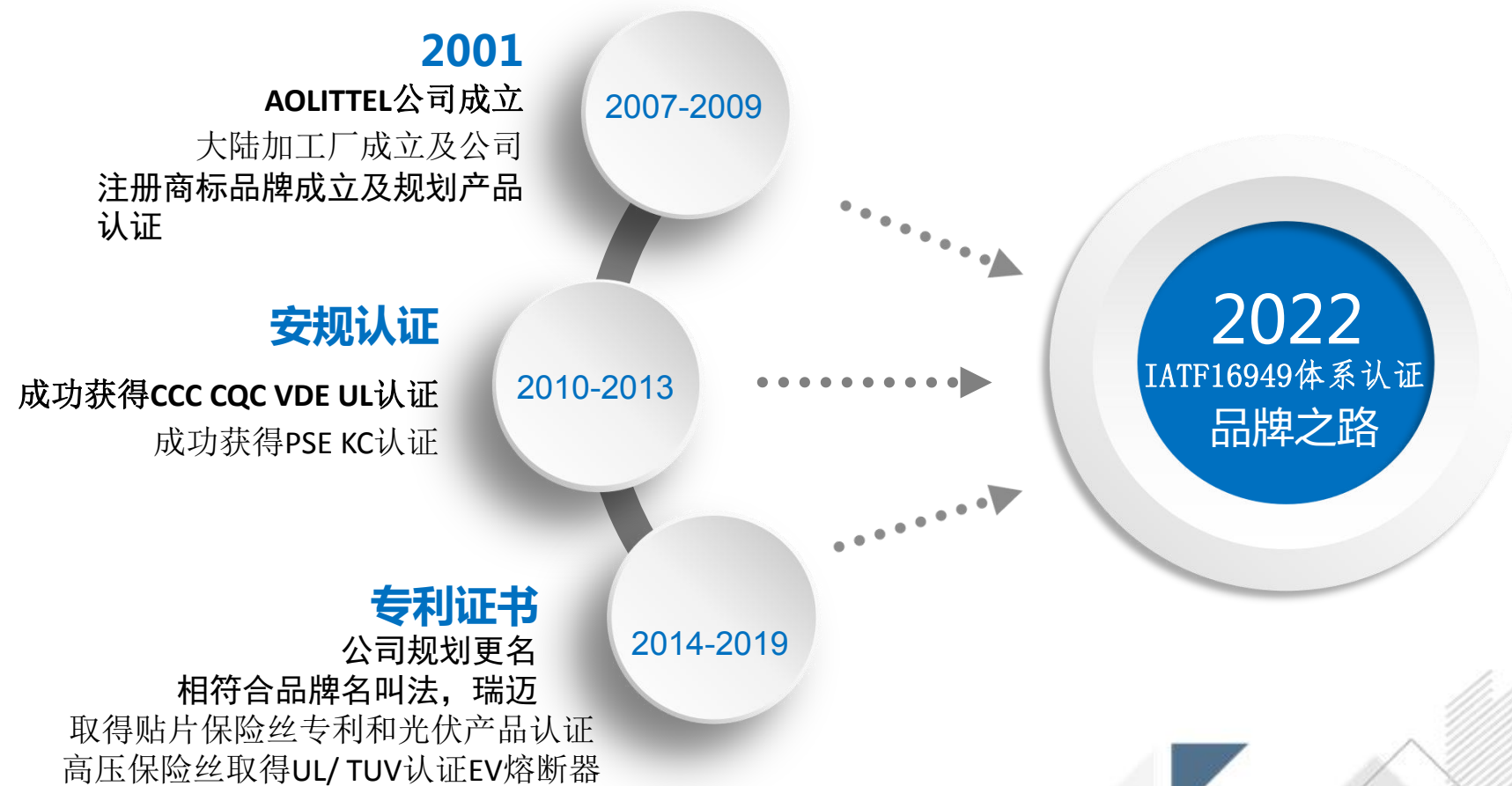

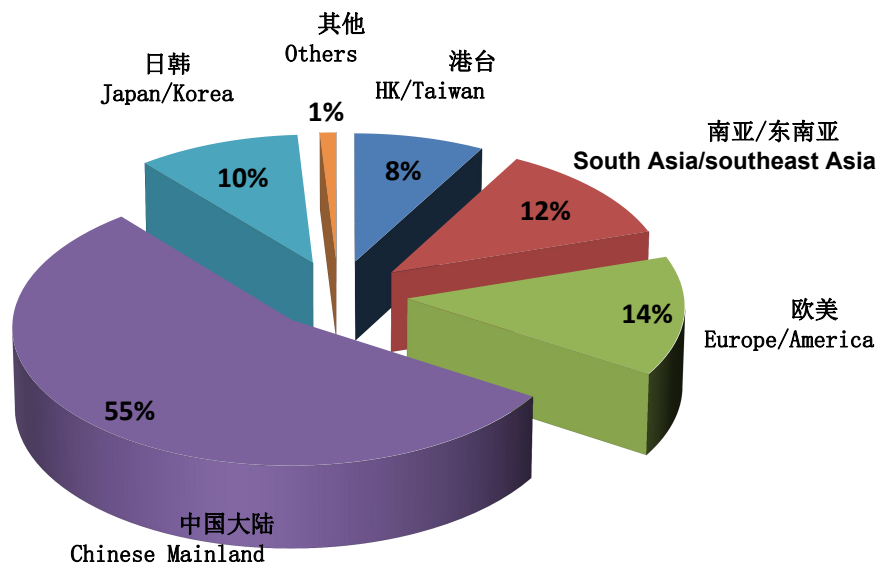

产品广泛应用于通讯设备、照明、电源、家用电器、电脑、汽车动力电子、智能电表等领域。
 Products are widely used in communication equipments, lighting, power supply, home appliance, computers, auto-motive electronics, smart meters and some other fields.



AOLITTEL

旗下事业部

PART 01 电流保险丝事业部

PART 05 汽车保险类事业部

PART 02 温度保险丝事业部

PART 06 热敏压敏事业部

PART 03 电感电阻器事业部

PART 07 温度传感器事业部

PART 04 自恢复保险丝事业部

PART 08 霍尔IC传感器事业部



诚信铸就品质

创新引领未来



RoHS
Compliance



REACH
Compliance



Halogen
Free

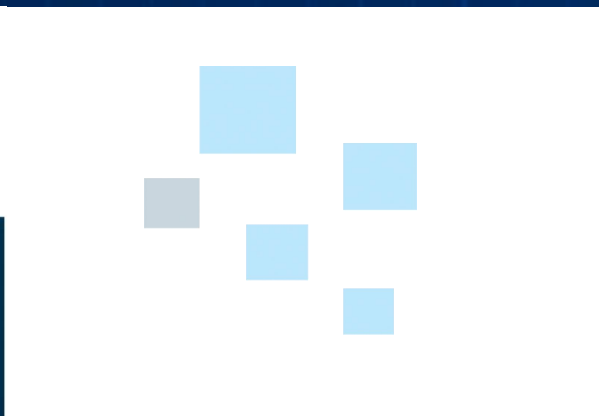

业务介绍

Intro Operation

FUSES

FUSES

★ 贴片保险丝, 塑封保险丝, 管状保险丝, 光伏保险丝, 电阻式保险丝, 线束保险丝座, 静电抑制器, 气体放电管, 汽车保险丝, 温度保险丝, 自恢复保险丝. 热敏压敏, 温度传感器, 霍尔IC传感器

★ 产品广泛用于电源供应器、开关电源、充电器、变压器、计算机、电话机、家用电器、通讯产品、灯饰产品、玩具产品、LED 节能灯、仪器仪表, 电子设备, 网卡, 太阳能电场装置、工业电力控制设备、各类仪器及各类电子电器连接线、电机产品、IT、消费电子、汽车、电池等领域。源于自主品牌 (AOLITTEL) (SINOBILE)



ABOUT US



FACTORY

产品介绍 Intro Operation

贴片保险丝SMD FUSES



应用领域: 笔记本电脑: 液晶显示器: 液晶背光逆变器: 电池组: 汽车导航系统: 网络设备: 便携式消费电子产品: 高功率电池系统: 集成模块

Laptops: LCD IED backlighting: the battery pack: car navigation system: network equipment: handheld/portable equipment: High power battery system: Integration module

| 型号TYPE T/F | R06.000. Fast Acting | 0603 | R06.100. Slow blow | 0603 | R12.000. Fast Acting | 1206 | R12.100. Slow blow | 1206 | R12.000. Fast Acting | 1206 | R12.100. Slow blow | 1206 |
|------------------------|-------------------------|------|-----------------------|------|-------------------------|------|-----------------------|------|-------------------------|------|-----------------------|------|
| 电流CURRENT | 0.25-8A | | 0.25-8A | | 0.25-40A | | 0.25-40A | | 1-3A | | 1-3A | |
| 电压VOLTAGE | 63VDC32VDC | | 63VDC32VDC | | 72VDC63VDC32VDC24VDC | | 72VDC63VDC32VDC24VDC | | 125V | | 125V | |
| 尺寸SIZE | 1.6*0.82*0.65mm | | 1.6*0.82*0.65mm | | 3.2*1.6*0.65mm | | 3.2*1.6*0.65mm | | 3.2*1.6*0.65mm | | 3.2*1.6*0.65mm | |
| 产品图片 PICTURES | | | | | | | | | | | | |
| 安规认证SAFETY APPROVED | | | | | | | | | | | | |

| 型号TYPE T/F | SET 2410 6125 1808 Slow blow | SEF 2410 6125 1808 Fast Acting | STE /STS 2410 6125 1808 Slow blow | SFE/SFS 2410 6125 1808 Fast Acting | SST 2410 6125 1808 Slow blow | SSF 2410 6125 1808 Fast Acting |
|------------------------|---------------------------------|-----------------------------------|--------------------------------------|---------------------------------------|---------------------------------|-----------------------------------|
| 电流CURRENT | 0.05-40A | | 0.05-40A | | 0.05-40A | |
| 电压VOLTAGE | 250V | | 250V | | 125V72V63V | |
| 尺寸SIZE | 6.1*2.5*2.5mm | | 6.1*2.5*2.5mm | | 6.1*2.5*2.5mm | |
| 产品图片 PICTURES | | | | | | |
| 安规认证SAFETY APPROVED | | | | | | |

产品介绍 Intro Operation

大电流贴片保险丝 HIGH-CURRENT SMD FUSES



应用领域: 5G通信: 锂电池: 电池组: 汽车系统: 网络设备: 便携式消费电子: 高功率电池系统: 集成模块: 分布式储能: 转换器: 逆变器: DC电源

Laptops: 5 G communications: lithium battery, battery pack, automotive systems, network equipment, portable consumer electronics: high power battery systems: integration module, distributed energy storage: converter, inverter, DC power

| 型号TYPE T/F | 1032F (R1032 1025) Fast Acting | 1032T (R1032 1025) Slow blow | R1032F (R1032 1025) Fast Acting | R1032T (R1032 1025) Slow blow | R1032F 1032F Fast Acting | R1032T 1032T Slow blow |
|------------------------|-----------------------------------|---------------------------------|------------------------------------|----------------------------------|---|---|
| 电流CURRENT | 0.05-60A | 0.05-60A | 0.05-60A | 0.05-60A | 0.2-5A | 0.5-5A |
| 电压VOLTAGE | 250V125V100V72V63V32V | 250V125V100V72V63V32V | 250V125V100V72V63V32V | 250V125V100V72V63V32V | 600V500V400V350V300V | 600V500V400V350V300V |
| 尺寸SIZE | 10*3.2*3.2mm | 10*3.2*3.2mm | 10*3.2*3.2mm | 10*3.2*3.2mm | 10*3.2*3.2mm | 10*3.2*3.2mm |
| 产品图片 PICTURES | | | | | | |
| 安规认证SAFETY APPROVED | | | | | | |
| 型号TYPE T/F | R1245F Fast Acting | R1245T Slow blow | 1250F Fast Acting | 1250T Slow blow | 5F/5T (SMD2050) Fast Acting /Slow blow | BMF/BMT (SMD3263) Fast Acting /Slow blow |
| 电流CURRENT | 0.5-100A | 0.5-100A | 0.5-5A | 0.5-5A | 0.5-60A | 0.5-60A |
| 电压VOLTAGE | 250V125V72V63V32V | 250V125V72V63V32V | 600V500V400V350V300V | 600V500V400V350V300V | 700V650V600V500V400V350V300V250V | 1000V850V600V500V400V350V300V250V |
| 尺寸SIZE | 12.4*4.5*4.5mm | 12.4*4.5*4.5mm | 12.4*4.5*4.5mm | 12.4*4.5*4.5mm | 5.0x5.0x20mm | 6.3*6.3*32mm |
| 产品图片 PICTURES | | | | | | |
| 安规认证SAFETY APPROVED | | | | | | |

产品介绍 Intro Operation

方型保险丝 Square FUSES



应用领域: PD快充电源: 照明设备: 电源适配器: 网络设备电源: 液晶显示器: 液晶背光逆变器: 音频、视频系统: 医疗设备: 便携式消费电子: 模块电源

Laptops: PD fast charging source: lighting: power adapter, network equipment, power supply, LCD monitor, LCD backlight inverter: audio and video systems, medical equipment, portable consumer electronics, power supply module

| 型号TYPE T/F | MTS Slow blow | | MFS Fast Acting | | NTS Slow blow | | NFS Fast Acting | | TMS Slow blow | | FMS Fast Acting | |
|------------------------|------------------|-------|--------------------|-------|------------------|-------|--------------------|-------|------------------|-------|--------------------|-------|
| 电流CURRENT | 0.05-25A | | 0.05-25A | | 0.05-25A | | 0.05-25A | | 0.05-25A | | 0.05-25A | |
| 电压VOLTAGE | 250V | | 250V | | 300V | | 300V | | 350V | | 350V | |
| 尺寸SIZE | 8*4*7.7mm | P=5mm | 8*4*7.7mm | P=5mm | 8*4*7.7mm | P=5mm | 8*4*7.7mm | P=5mm | 8*4*7.7mm | P=5mm | 8*4*7.7mm | P=5mm |
| 产品图片 PICTURES | | | | | | | | | | | | |
| 安规认证SAFETY APPROVED | | | | | | | | | | | | |

| 型号TYPE T/F | MTC Slow blow | | MFC Fast Acting | | TMS Slow blow | | FMS Fast Acting | | 96T Slow blow | | 96F Fast Acting | |
|------------------------|------------------|-------|--------------------|-------|------------------|-------|--------------------|-------|------------------|-------|--------------------|-------|
| 电流CURRENT | 0.05-20A | | 0.05-20A | | 0.5-25A | | 0.5-25A | | 0.05-30A | | 0.05-30A | |
| 电压VOLTAGE | 250V/300V | | 250V/300V | | 400V/500V | | 400V/500V | | 250V-500V | | 250V-500V | |
| 尺寸SIZE | 8*4*5mm | P=5mm | 8*4*5mm | P=5mm | 8*4*7.7mm | P=5mm | 8*4*7.7mm | P=5mm | 12*6*9mm | P=7mm | 12*6*9mm | P=7mm |
| 产品图片 PICTURES | | | | | | | | | | | | |
| 安规认证SAFETY APPROVED | | | | | | | | | | | | |

产品介绍 Intro Operation

电子保险丝 ELECTRONIC FUSES



应用领域: PD快充电源: 照明设备: 电源适配器: 网络设备电源: 液晶显示器: 液晶背光逆变器: 音频、视频系统: 医疗设备: 便携式消费电子: 模块电源

Laptops: PD fast charging source: lighting: power adapter, network equipment, power supply, LCD monitor, LCD backlight inverter: audio and video systems, medical equipment, portable consumer electronics, power supply module

| 型号TYPE T/F | STB Slow blow | SFB Fast Acting | RTP Slow blow | RFP Fast Acting | AFB/ATB Slow blow | AFB Fast Acting |
|------------------------|------------------|--------------------|------------------|--------------------|----------------------|--------------------|
| 电流CURRENT | 0.05-15A | 0.05-15A | 0.05-15A | 0.05-15A | 1-3A | 1-3A |
| 电压VOLTAGE | 125V 250V | 125V 250V | 350V | 350V | 250V | 250V |
| 尺寸SIZE | 3*7.7mm | 3*7.7mm | 4*11mm | 4*11mm | 2.5*6.5mm | 2.9*8.5mm |
| 产品图片 PICTURES | | | | | | |
| 安规认证SAFETY APPROVED | | | | | | |

| 型号TYPE T/F | STP Slow blow | SFP Fast Acting | TBP Slow blow | FBP Fast Acting | PTU/HTP/TBP Slow blow | PFU/HFP Fast Acting |
|------------------------|------------------|--------------------|------------------|--------------------|--------------------------|------------------------|
| 电流CURRENT | 0.05-15A | 0.05-15A | 0.05-15A | 0.05-15A | 0.05-15A | 0.05-15A |
| 电压VOLTAGE | 250V/125V | 250V/125V | 250V | 250V | 250V | 250V |
| 尺寸SIZE | 3.6*10mm | 3.6*10mm | 3.6*10mm | 3.6*10mm | 3.6*10mm | 3.6*10 |
| 产品图片 PICTURES | | | | | | |
| 安规认证SAFETY APPROVED | | | | | | |

产品介绍 Intro Operation

电阻器 RESISTOR



应用领域: PD快充电源: 照明设备: 电源适配器: 网络设备电源: 液晶显示器: 液晶背光逆变器: 音频、视频系统: 医疗设备: 便携式消费电子: 模块电源

Laptops: PD fast charging source: lighting: power adapter, network equipment, power supply, LCD monitor, LCD backlight inverter: audio and video systems, medical equipment, portable consumer electronics, power supply module

| 型号TYPE | KNP/NKNP 绕线电阻/保险电阻 | MOF 氧化膜 | MF 金属膜 | MGR 玻璃釉 (高压电阻) | KNP/FKNP 防爆绕线电阻 | CF 碳膜 |
|------------------|-----------------------------|-----------------------------|------------------------------|-------------------|-----------------------------|-------------------------------|
| 阻值resistance | 0.05R-250R | 0.1R-100K | 1R-10MR | 100K-39MR | 0.05R-250R | 1R-10MR |
| 电压VOLTAGE | 250V 300V-400V | 250V-750V-1000V | 150V-250V-300V-1000V | 500V-1000V | 300V-400V | 250V-500W |
| POWER RATING | 1/2W1WS1 W2W2W 3WS3 W5WS 5W | ¼-1/2W1WS1W2W2WS3WS3W5WS 5W | 1/6-8W1/4W1/2W1WS1 W2W2W 3WS | 1/4W 1/2W 1W 2W | 1/2W1WS1 W2W2W 3WS3 W5WS 5W | 1/6-8W1/4W1/2W1WS1W2W2W 3WS3W |
| 产品图片 PICTURES | | | | | | |
| ROHS | | | | | | |

| 型号TYPE | SMD RXM/FXM 贴片保险电阻 | SMD MF 贴片金属膜 | SMD CF 贴片碳膜 | AH 黄金铝壳 | CEMENT TYPE 水泥电阻 | AL 电力型铝壳 |
|------------------|-----------------------|---------------------|----------------|------------|---------------------|-------------|
| 阻值resistance | 0.05R-250R | 1R-10MR | 1R-10MR | 1-100K | 1R-100KR | 0.1-100K |
| 电压VOLTAGE | 250V 300V-400V | 150V-250V-300V-750V | 250V-500V | 2000V | 250V-500V | 2000V |
| POWER RATING | 0207 0309 0410 | 0207 0309 0410 | 0207 0309 0410 | 5-100W | 2W-40W | 60W-1000W |
| 产品图片 PICTURES | | | | | | |
| ROHS | | | | | | |

产品介绍 Intro Operation

自恢复保险丝 PPTC FUSES



应用领域: PD快充电源: 照明设备: 电源适配器: 网络设备电源: 液晶显示器: 液晶背光逆变器: 音频、视频系统: 医疗设备: 便携式消费电子: 模块电源

Laptops: PD fast charging source: lighting: power adapter, network equipment, power supply, LCD monitor, LCD backlight inverter: audio and video systems, medical equipment, portable consumer electronics, power supply module

| 型号TYPE | 0603 PPTC | 0805 PPTC | 1210 PPTC | 1206 PPTC | 1812 PPTC | 2018 PPTC |
|---------------|-----------|-----------|-----------|-----------|-----------|-----------|
| 电流CURRENT | 0.01-1A | 0.05-1.5A | 0.05-2.6A | 0.05-3.5A | 0.1-4A | 0.3-2A |
| 电压VOLTAGE | 6-16V | 6-24V | 6-30V | 6-48V | 6-60V | 10-60V |
| SIZE封装 | 0603 | 0805 | 1210 | 1206 | 1812 | 2018 |
| 产品图片 PICTURES | | | | | | |
| ROHS | | | | | | |

| 型号TYPE T/F | 2920 PPTC | TRA PPTC | TRB PPTC | TRC PPTC | TRF PPTC | GR265 PPTC |
|---------------|-----------|----------|----------|----------|----------|------------|
| 电流CURRENT | 0.3-7A | 0.05-14A | 0.9-9A | 0.05-5A | 0.02-2A | 0.01-5A |
| 电压VOLTAGE | 6-60V | 16V | 30V | 60/72V | 250V | 265V |
| SIZE封装 | 2920 | DIP | DIP | DIP | DIP | DIP |
| 产品图片 PICTURES | | | | | | |
| ROHS | | | | | | |

合金精密电阻 Alloy precision resistance

ESD静电保护：霍尔IC传感器 Hall sensor：三端保险丝 three-terminal FUSES

应用领域：5G通信：锂电池：电池组：汽车系统：网络设备：仪器仪表：便携式消费电子：高功率电池系统：集成模块：分布式储能：转换器：逆变器：DC电源
 Laptops: 5 G communications: lithium battery, battery pack, automotive systems, network equipment, Instrument and meter : portable consumer electronics: high power battery systems: integration module, distributed energy storage: converter, inverter, DC power



| 型号TYPE T/F | ALHJ 合金精密电阻 | ALHJ 合金精密电阻 | ALTCY 合金采样电阻 | ALTCY 合金采样电阻 | WA/WPF 三端保险丝 | PPTC/CLM 三端保险丝 |
|---------------|-------------|-------------|--------------|--------------|-----------------|-----------------|
| 功率power | 1W-2W | 2W-3W | 2W-10W | 0.5W-15W | 电流CURRENT12-45A | 电流CURRENT12-45A |
| 阻值resistance | R001-R500 | R001-R500 | 0.2MR-5MR | 0.0005R-0.5R | 36V-80V | 36V-80V |
| SIZE封装 | 0603-1206 | 2512 | 2512-5930 | 2512-5930 | 1612 2213 3820 | 1612 2213 3820 |
| 产品图片 PICTURES | | | | | | |
| ROHS | | | | | | |

| 型号TYPE T/F | ESD 静电抑制器 | ESD 静电抑制器 | Hall sensor(速度方向)霍尔IC 磁性开关位置传感器 | Hall sensor霍尔IC 磁线性可编程传感器 | Hall sensor(速度方向)霍尔IC 高精度线性霍尔传感器 | Hall sensor、AH910霍尔IC 霍尔电流传感器 |
|---------------|---------------------------|---------------------------|---------------------------------|---------------------------|----------------------------------|-------------------------------|
| 特性Features | 低泄漏电流、低钳位电压、快速响应时间 (<1ns) | 低泄漏电流、低钳位电压、快速响应时间 (<1ns) | 磁工作点 (Gs) 9-133 | 65KHz/线性输出 | 磁工作点 (Gs) 9-133 | 65KHz/线性输出 |
| 电压VOLTAGE | 5V 10V 24V | 5V 10V 24V | 2.7-60V | 4.5V-5.5V | 2.7-60V | 4.5V-5.5V |
| SIZE封装 | 0201 0402 0603 | 2510 | SOT23 TO92S | TO94 SOP8 | SOT23 TO92S TO94 | SOP8 |
| 产品图片 PICTURES | | | | | | |
| ROHS | | | | | | |

产品介绍 Intro Operation

电感器类 Inductance



应用领域: PD快充电源: 照明设备: 电源适配器: 网络设备电源: 液晶显示器: 液晶背光逆变器: 音频、视频系统: 医疗设备: 便携式消费电子: 模块电源

Laptops: PD fast charging source: lighting: power adapter, network equipment, power supply, LCD monitor, LCD backlight inverter: audio and video systems, medical equipment, portable consumer electronics, power supply module



| 型号TYPE T/F | ALTSQ 共模电感 | ALTSH 色环电感 | ALTGZ 工字电感 | ALTEH 磁环电感 | ALTUU 滤波器电感 | ALTEE 共模电感 |
|------------------------|---------------|---------------|---------------|---------------|----------------|---------------|
| 电流CURRENT | 0.5-25A | 0.07-1.4A | 0.23-5A | 0.25-5A | 0.02-3A | 0.3-6A |
| 感量Sensible quantity | 0.4MH-85MH | 0.22UH-39MH | 1UH-100MH | 1UH-50MH | 0.5MH-100MH | 0.5MH-80MH |
| 尺寸SIZE | 1010-3224 | 0204-0512 | 3*4-14*15 | 633-856220 | UU9.8-UU16 | EE8.3-EE25 |
| 产品图片 PICTURES | | | | | | |
| ROHS | | | | | | |

| 型号TYPE T/F | ALTDC 叠层电感 | ALTRX 贴片绕线电感 | ALTYT 一体成型电感 | ALTCD 贴片功率电感 | ALTRH 方形功率电感 | ALTNR 磁胶屏蔽电感 |
|------------------------|---------------|-----------------|-----------------|-----------------|-----------------|-----------------|
| 电流CURRENT | 1MA-500MA | 0.05-40A | 2.2-112A | 0.021-9.8A | 0.14-12A | 0.4-13.8A |
| 感量Sensible quantity | 0.001UH-100UH | 0.0008UH-33UH | 0.1UH-220UH | 0.47UH-10000UH | 1UH-1000UH | 0.22UH-1500UH |
| 尺寸SIZE | 0402-1206 | 0402-1812 | 0412-1770 | 32-108 | 62-159 | 2520-8040 |
| 产品图片 PICTURES | | | | | | |
| ROHS | | | | | | |

温度保护类: Temperature protection class

NTC热敏 / 压敏类 NTC thermal/pressure sensitive



应用领域: 家用电器: PD快充电源: 照明设备: 电源适配器: 网络设备电源: 液晶显示器: 液晶背光逆变器: 音频、视频系统: 医疗设备: 便携式消费电子: 工控设备
 Laptops: Household appliances: PD fast charging source: lighting: power adapter, network equipment, power supply, LCD monitor, LCD backlight inverter: audio and video systems, medical equipment, portable consumer electronics, power supply module

| 型号TYPE T/F | 方形温度保险丝 | 电阻式温度保险丝 | 铁壳温度保险丝 | RH温度保险丝 | KSD9700温度开关 | KSD301温控器 |
|--------------|------------------|------------------|----------|---------|-------------|-----------|
| 电流CURRENT | 0.5A 1A 2A 3A 5A | 0.5A 1A 2A 3A 5A | 10A-15A | 0.5-30A | 0.5-30A | 10A |
| 电压VOLTAGE | 125/250V | 125/250V | 125/250V | 700V | 250V | 2500V |
| temperature | 57-240度 | 57-240度 | 57-240度 | 57-300度 | 45-240度 | 5-250度 |
| 产品图片PICTURES | | | | | | |
| ROHS | | | | | | |

| 型号TYPE T/F | 贴片NTC热敏电阻 | 贴片压敏电阻 | 贴片压敏电阻 | 压敏电阻 | GDT放电管 | SMD GDT贴片放电管 |
|--------------|--------------------------|--------------------------|---------------|-----------------------|-------------|----------------|
| 参数parameter | 3380K 3950K 4250K | 0805 1206 1210 1812 2220 | 3225 | 5D 7D 10D 14D 20D 25D | 2R8 3R8 5*6 | 1206 4532 1812 |
| 电压VOLTAGE | 250V | 241 471V | 361 471 561 V | 361 471 561 711V | 70-3600V | 75V-1100V |
| 尺寸SIZE | 0201 0402 0603 0805 1206 | 0805 1206 1210 1812 2220 | 3225 | 5D 7D 10D 14D 20D 25D | 2R8 3R8 5*6 | 1206 4532 1812 |
| 产品图片PICTURES | | | | | | |
| ROHS | | | | | | |

NTC温度传感器类: NTC temperature sensor



温度传感器、可要求定制: The temperature sensor, may require customization

应用领域: 家用电器: PD快充电源: 照明设备: 电源适配器: 网络设备电源: 液晶显示器: 液晶背光逆变器: 锂电池: 电池组: 医疗设备: 便携式消费电子: 一块电池
 Laptops: Household appliances: PD fast charging source: lighting: power adapter, network equipment, power supply, LCD monitor, LCD backlight inverter, lithium battery, battery pack, medical equipment, portable consumer electronics, power supply module



| 型号TYPE T/F | MF51E303E3950 NTC温度计热敏电阻 | MF52 50mW 功率 NTC 热敏电阻 | MF52D 103F3950L51 环氧涂层NTC热敏电阻 | MF51 玻璃珠热敏电阻 | MF58 100K 玻璃封装 NTC 热敏电阻 | MF72 5D-13 NTC型热敏电阻 |
|----------------------|----------------------------------|-------------------------------|----------------------------------|-----------------------------|---------------------------------|------------------------|
| B值B value | 3950K±0.5% | 3380K ~ 4150K | 10KΩ±1% | 3480K ~ 4240K | 3950K | 2800K |
| 温度The temperature | -40°C - +100°C | -55 ~ +125°C | -40°C ~ 105°C | -55 ~ +300°C | -55 ~ +250°C | -40C~+150C |
| 尺寸SIZE | 120*1.8*5 | 28*1.8*3.2 | 50*2.5*7.5 | 32*1.8*2.5 | 60*2*4 | 15.5*5*7 |
| 产品图片 PICTURES | | | | | | |
| ROHS | | | | | | |
| 型号TYPE T/F | NSAB1503HD3-301S2M1 烧烤探针温度传感器 | CWF103F3984FB150RC 环儿温度传感器 | 2k Ohm 4000 不锈钢探头温度传感器 | CWFM0103FC1- ABS防水壳温度传感器 | CWF0103FC2-152T6C NTC不锈钢感应探头 | CWF IP68防水温度传感器 |
| B值B value | 3970K | 3984K±1% | 0.23-5A | 3950K±1% | 10KOHM | 3950 10k |
| 温度The temperature | -30~+250°C | -40~+150°C | -40~+105°C/+125°C | -30~+105°C | -40~+105°C/+125°C | -55~+125°C |
| 尺寸SIZE | 550*19*165定制 | 80*5.4*16.4定制 | 定制 | 定制 | 471566定制 | 定制 |
| 产品图片 PICTURES | | | | | | |
| ROHS | | | | | | |

汽车保险丝类: AUTO FUSES

大电流叉栓/螺栓汽车保险丝类: AUTO FUSES



应用领域: 5G通信: 锂电池: 电池组: 汽车系统: 网络设备: 便携式消费电子: 高功率电池系统: 集成模块: 分布式储能: 转换器: 逆变器: DC电源

Laptops: 5 G communications: lithium battery, battery pack, automotive systems, network equipment, portable consumer electronics: high power battery systems: integration module, distributed energy storage: converter, inverter, DC power

| 型号TYPE T/F | ATN/AB11 小号汽车保险丝 | ATY/AB19 中号汽车保险丝 | ATM/AB29 大号汽车保险丝 | GPC 东欧汽车保险丝 | MINIAB10 平角汽车保险丝 | FLE/FLS 方型盒保险丝 |
|------------------|---------------------|---------------------|---------------------|----------------|---------------------|-------------------|
| 电流CURRENT | 1-40A | 0.5-50A | 20-100A | 5-30A | 1-40A | 20-60A |
| 电压VOLTAGE | 32V-58V | 32V-58V | 32V-58V | 32V | 32V-58V | 32V |
| 尺寸SIZE | 11*4*16 | 19*5*18 | 34*9*22 | 6*24 | 11*4*10 | 13*19*30 |
| 产品图片 PICTURES | | | | | | |
| ROHS | | | | | | |

| 型号TYPE T/F | ANL 大号叉栓保险丝 | AN498/ANS 小号螺栓保险丝 | ANM 螺栓汽车保险丝 | FLM 卡匣式 车用保险丝 | FLE/FLN 方形盒汽车保险丝 | FLK 方形短母插保险丝 |
|------------------|----------------|----------------------|----------------|------------------|---------------------|-----------------|
| 电流CURRENT | 25-400A | 30-200A | 40-400A | 20-120A | 20-120A | 20-120A |
| 电压VOLTAGE | 32V | 32V | 32V | 32V | 32V | 32V |
| 尺寸SIZE | 80*9*19 | 42*8.5*12 | 68*10*19 | 22*15*43.7 | 14*12*27 | 22*12*31 |
| 产品图片 PICTURES | | | | | | |
| ROHS | | | | | | |

汽车安装保险丝座



AUTO Panel Mounting Fuse holder



| 型号TYPE | Z-506J (BA) 汽车保险丝支架 | Z-506M 汽车保险丝支架 | Z-506P 汽车保险丝支架 | Z-506N 汽车保险丝支架 | Z-506PA 汽车保险丝支架 | Z-506BA 汽车保险丝支架 |
|------------------|------------------------|-------------------|-------------------|-------------------|--------------------|---------------------|
| CURRENT/Max | 30A | 40A | 30A | 40A | 30A | 40A |
| 电压VOLTAGE | 32V 58V 85V | 32V 58V 85V | 32V 58V 85V | 32V 58V 85V | 32V 58V 85V | 32V 58V 85V |
| 尺寸SIZE | 中号插片 | 中号插片 | 中号插片 | 中号插片 | 小号中号插片 | 中号插片 |
| 产品图片 PICTURES | | | | | | |
| ROHS | | | | | | |
| 型号TYPE | Z-506A 汽车保险丝支架 | Z-506K 汽车保险丝支架 | Z-506B 汽车保险丝支架 | Z-703C 汽车保险丝支架 | Z-703F 汽车保险丝支架 | 中号250旗端子 汽车保险丝支架 |
| CURRENT/Max | 30A | 40A | 30A | 30A | 30A | 40A |
| 电压VOLTAGE | 32V 58V 85V | 32V 58V 85V | 32V 58V 85V | 32V 58V 85V | 32V 58V 85V | 32V 58V 85V |
| 尺寸SIZE | 小号中号插片 | 小号中号插片 | 小号中号插片 | 小号插片 | 小号中号插片 | 小号中号插片 |
| 产品图片 PICTURES | | | | | | |
| ROHS | | | | | | |

汽车安装保险丝座



AUTO Panel Mounting Fuse holder



| 型号TYPE | Z-703E 汽车保险丝 | Z-703FA 汽车保险丝 | Z-703E2 汽车保险丝 | Z-703H 汽车保险丝 | Z-703E2A 汽车保险丝 | Z-703H2A 汽车保险丝 |
|------------------|--|--|--|--|--|--|
| CURRENT/Max | 30A | 30A | 30A | 30A | 30A | 30A |
| 电压VOLTAGE | 32V 58V 85V | 32V 58V 85V | 32V 58V 85V | 32V 58V 85V | 32V 58V 85V | 32V 58V 85V |
| 尺寸SIZE | 中号插片 | 中号插片 | 中号插片 | 中号插片 | 中号插片 | 中号插片 |
| 产品图片 PICTURES | | | | | | |
| ROHS | 1.30A 32V AC 2. Medium blade fuse 3. Nylon | 1.30A 32V AC 2. Medium blade fuse 3. Nylon | 1.30A 32V AC 2. Medium blade fuse 3. Nylon | 1.30A 32V AC 2. Medium blade fuse 3. Nylon | 1.30A 32V AC 2. Medium blade fuse 3. Nylon | 1.30A 32V AC 2. Medium blade fuse 3. Nylon |
| 型号TYPE | Z-703D 汽车保险丝 | Z-703G 汽车保险丝 | Z-06.087 汽车保险丝 | Z-06.088 汽车保险丝 | Z-703B 汽车保险丝 | Z-707 汽车保险丝 |
| CURRENT/Max | 30A | 30A | 30A | 30A | 30A | 30A |
| 电压VOLTAGE | 32V 58V 85V | 32V 58V 85V | 32V 58V 85V | 32V 58V 85V | 32V 58V 85V | 32V 58V 85V |
| 尺寸SIZE | 中号插片 | 中号插片 | 小号中号插片 | 小号中号插片 | 中号插片 | 小号中号插片 |
| 产品图片 PICTURES | | | | | | |
| ROHS | 1.30A 32V AC 2. Medium blade fuse 3. Nylon | 1.30A 32V AC 2. Medium blade fuse 3. Nylon | | | | B:20A C:100MG Min D:5mm Al 1A DC E:AC1500V Min. F:Nylon G:14#AWG 8" Loop Interlock For Multiple Mounting For ATQ Blade Type Fuses |

保险丝座类: Fuse holder

PCB线路板安装保险丝座PCB Mounting Fuse holder

汽车安装保险丝座 AUTO Panel Mounting Fuse holder

RoHS Compliance | REACH Compliance | Halogen Free



| 型号TYPE T/F | MTS/TE5/5ET/392 方型保险丝座 | MMT/382/MET 圆形保险丝座 | SET/0154/2410 6125 1808 贴片保险丝座 | PTF-50 保险丝座 | BLX-A 保险丝座 | PTF-35 保险丝座 |
|------------------|---------------------------|-----------------------|-----------------------------------|------------------|------------------|------------------|
| 电流CURRENT | 50mA-20A | 50mA-20A | 50mA-30A | 0.25-20A | 0.25-20A | 0.5-20A |
| 电压VOLTAGE | 250V300V350V | 250V300V350V | 63V 72V 125V 250V 300V | 250V | 250V | 250V |
| 尺寸SIZE | 8*4*7.7 | 8.5*8*7.2 | 1808 6125 2410 | 5.2*20 | 5.2*20 | 5.2*20 |
| 产品图片 PICTURES | | | | | | |
| ROHS | | | | | | |
| 型号TYPE T/F | ANM-B 汽车叉栓底座 | ANM-C 汽车叉栓底座 | ANS-H/NIDI-498 汽车叉栓底座 | ANM-B2 汽车螺栓底座 | MEGA 汽车螺栓底座 | ANM-B4 汽车螺栓底座 |
| 电流CURRENT | 25-400A | 25-400A | 25-400A | 25-400A | 25-400A | 25-400A |
| 电压VOLTAGE | 32V 58V 85V 125V | 32V 58V 85V 125V | 32V 58V 85V 125V | 32V 58V 85V 125V | 32V 58V 85V 125V | 32V 58V 85V 125V |
| 尺寸SIZE | ANM-B | ANM-C | ANS-H/NIDI-498 | ANM-B2 | MEGA | ANM-B4 |
| 产品图片 PICTURES | | | | | | |
| ROHS | | | | | | |

汽车保险丝包装 Auto fuse packaging

RoHS Compliance REACH Compliance Halogen Free



跨境电商/零售Cross-border electricity/retail

| | | | | | | |
|------------------------|----------------------|----------------------|----------------------|----------------------|----------------------|----------------------------|
| 型号TYPE T/F | ALTHZ240 240盒装保险片 | ALTXHKB10 小号卡板保险片 | ALTHZ100 100盒装保险片 | ALTDOKB10 东欧卡板保险丝 | ALTHZ100 100盒装保险片 | ALTBLKB5 5*20/6*30卡板保险丝 |
| 电流CURRENT | 3-50A | 7.5-30A | 3-50A | 5-25A | 3-50A | 100MA-30A |
| 电压VOLTAGE | 32V | 32V | 32V | 32V | 32V | 250V |
| 尺寸SIZE | 240只盒装 | 10只卡装 | 100只盒装 | 10只卡装 | 100只盒装 | 5*20/6*30/6.35*32 |
| 产品图片 PICTURES | | | | | | |
| 安规认证SAFETY APPROVED | | | | | | |
| 型号TYPE T/F | ALTZHKB10 中号卡板保险片 | ALTHZ100 100盒装保险片 | ALTZHKB10 中号卡板保险片 | ALTHZ100 100盒装保险片 | ALTZHKB10 中号卡板保险片 | ALTHZ100 100盒装保险片 |
| 定制custom | 5-30A | 3-50A | 5-30A | 3-50A | 5-30A | 1-40A |
| 电压VOLTAGE | 32V | 32V | 32V | 32V | 32V | 32V |
| 尺寸SIZE | 10只卡装 | 100只盒装 | 10只卡装 | 100只盒装 | 10只卡装 | 100只盒装 |
| 产品图片 PICTURES | | | | | | |
| 安规认证SAFETY APPROVED | | | | | | |

汽车保险丝安装座 AUTO Panel Mounting Fuse holder



| 型号TYPE T/F | 降压线 | 2进4出多路座子 | 1进12出多路座子 | 2进12出多路座子 | 8路多路座子 | 12路多路座子 |
|------------------------|---|---|--|---|---|---|
| 定制custom | 定制custom | 定制custom | 定制custom | 定制custom | 定制custom | 定制custom |
| 电压VOLTAGE | 32V58V | 32V58V | 32V58V | 32V58V | 32V58V | 32V58V |
| 尺寸SIZE | 小号中号 | 小号中号 | 小号中号 | 小号中号 | 小号中号 | 小号中号 |
| 产品图片 PICTURES |  |  |  |  |  |  |
| 安规认证SAFETY APPROVED | 降压线 | 2进4出多路座子 | 一进12出多路座子 | 2进12出多路座子 | 8路多路座子 | 12路多路座子 |
| 型号TYPE T/F | 2进8出多路座子 | 1进10出多路座子 | 1进6出多路座 | ANL-H 汽车叉栓底座 | 550电瓶保险片5路7路 ANG保险丝座汽车保险丝座 | PVRHIU |
| 定制custom | 定制custom | 定制custom | 定制custom | 25-400A | 5-100A | 1-30A |
| 电压VOLTAGE | 32V58V | 32V58V | 32V58V | 32V58V | 32V 58V | 1000V/1500V |
| 尺寸SIZE | 小号中号 | 小号中号 | 小号中号 | 汽车叉栓底座 | 5.2*20 | 10*38 |
| 产品图片 PICTURES |  |  |  |  |  |  |
| 安规认证SAFETY APPROVED | 2进8出多路座子 | 一进10出多路座子 | 1进6出多路座 | ANL透明座 | MK4 电瓶保险丝盒 | |

光伏熔断器.EV直流熔断器

Photovoltaic PV fuse. EV dc fuse



产品应用型号



| | |
|---------|-------|
| PV1000V | 1-15A |
| PV1500V | 1-50A |
| PVRH1U | 保险丝座子 |

产品应用型号

| | |
|---------|-----------|
| DC500V | 5A-1200A |
| DC700V | 5A-800A |
| DC1000V | 35A-2000A |





应用领域

Application field



EXAMPLES



Street Lighting
50-200W

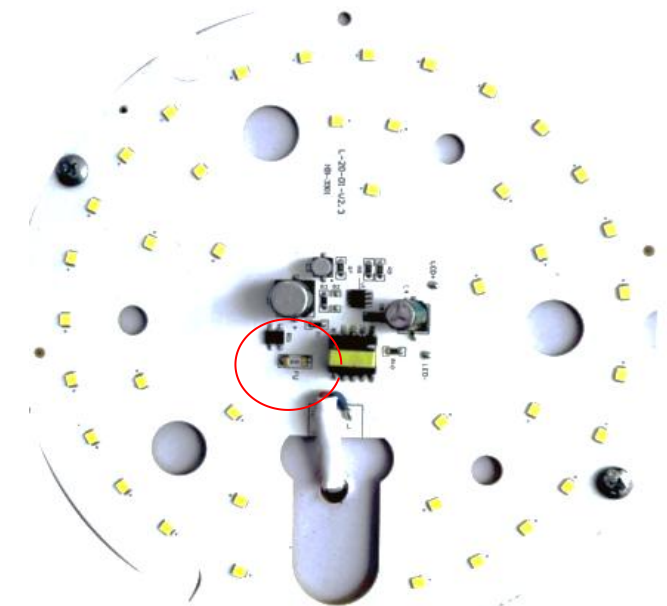
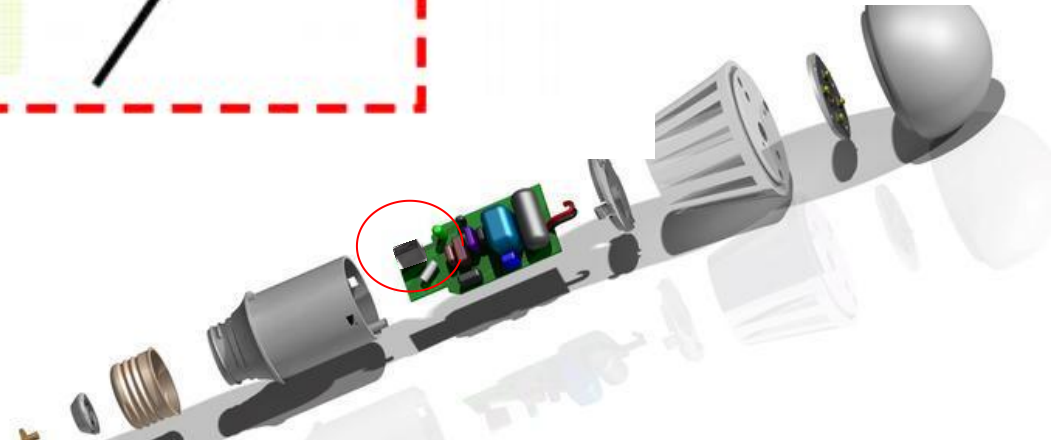
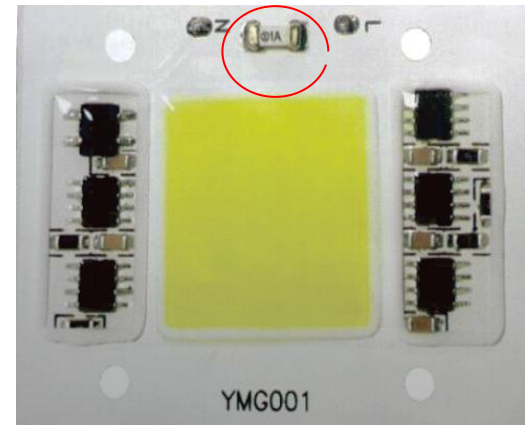
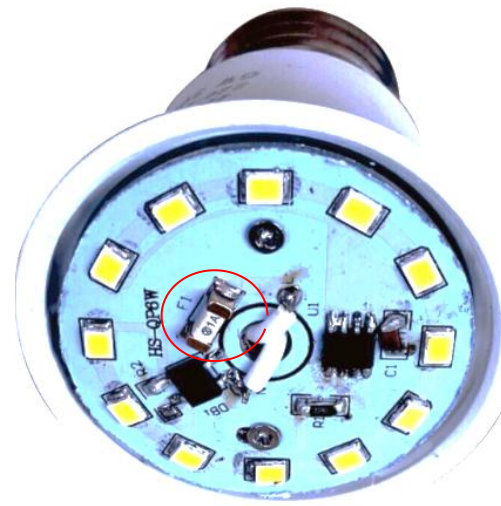



马达用



位置探测

- CVT- 变速箱传感器
- 雨刮位置传感器
- 离合器踏板位置
- 刹车位置 (刹车灯)
- 安全带
- 方向盘锁
- 后备箱锁
- 门锁
- 换挡器位置
- 座位位置

无刷直流电机 电机换相

- 发动机制冷风扇
- 天窗
- 进气扇
- 电动助力转向
- 双离合和手自一体
- 转速表传感器
- 窗电机(防夹功能)
- 泵
- 座位电机
- 交变电机
- 曲柄
- 凸轮轴

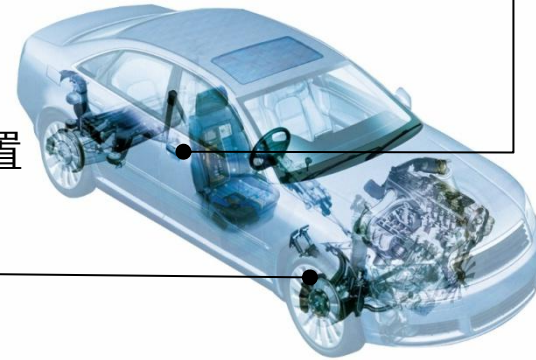

应用领域 Application field

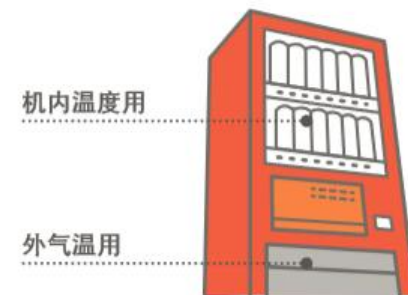
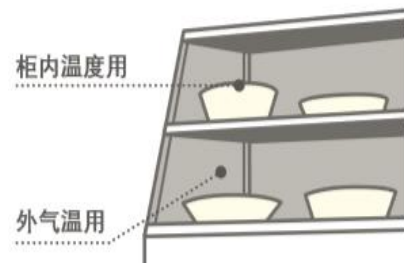
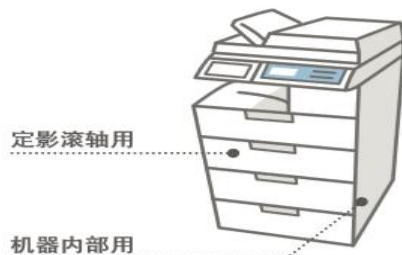
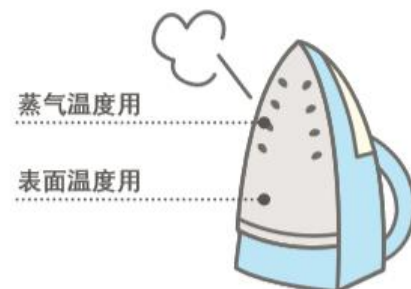
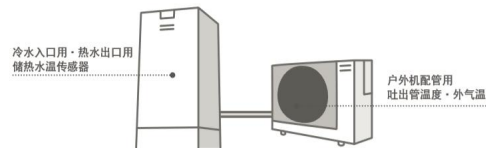
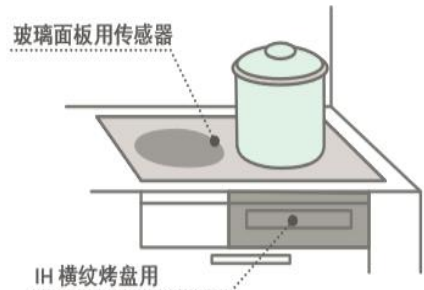

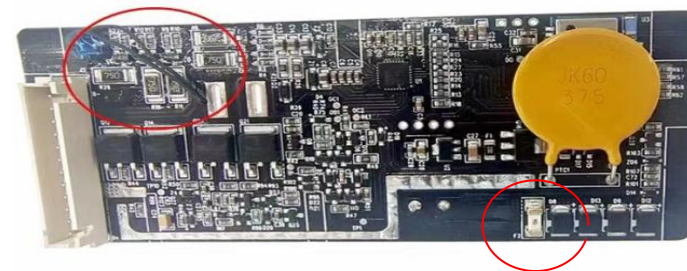
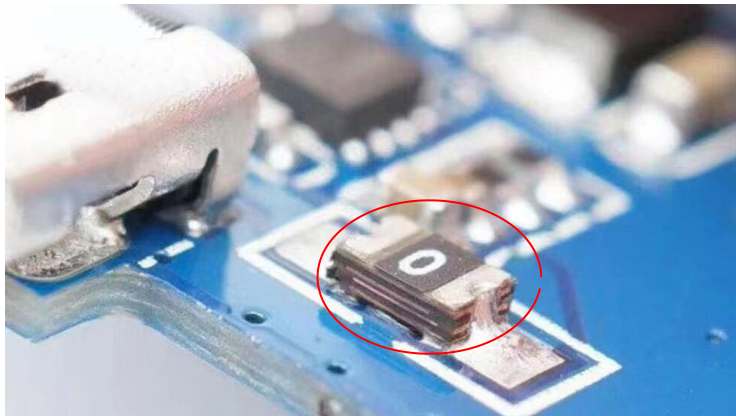

NTC+PTC+FUSE控制板上应用

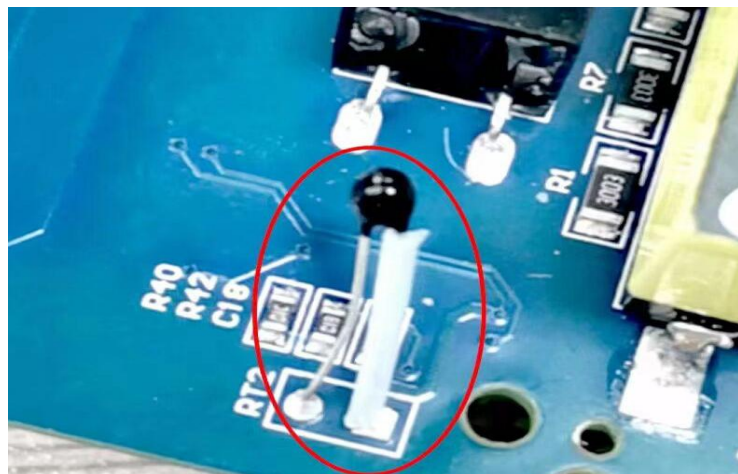

TB02温度开关、温控器
30-155度、2-5A可选

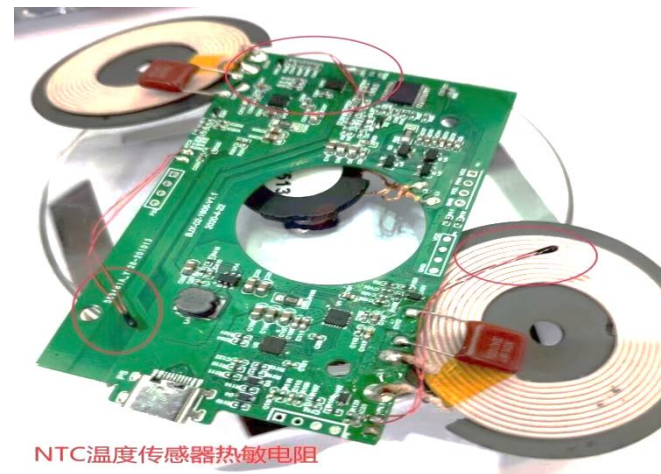

NTC温度传感器热敏电阻

应用领域

Application field

AOLITTEL



充电桩



高压配电箱



电池系统



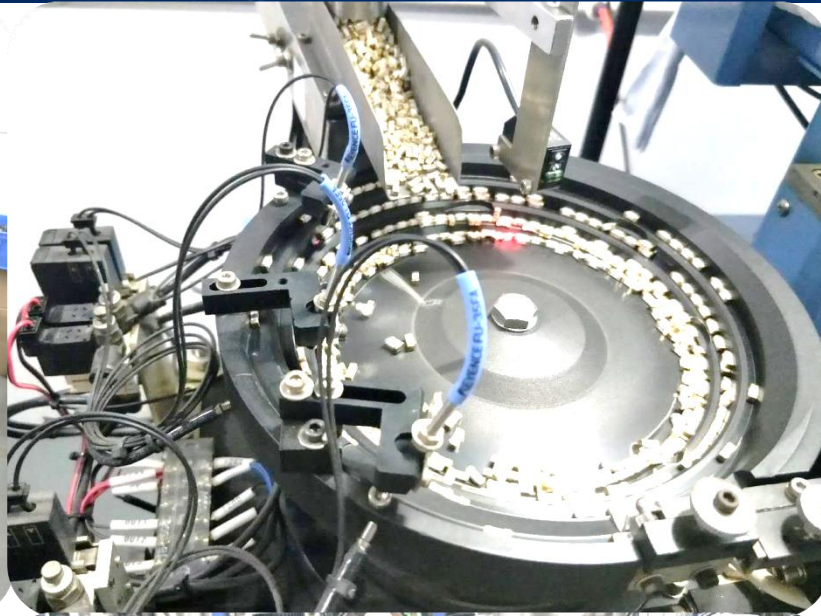

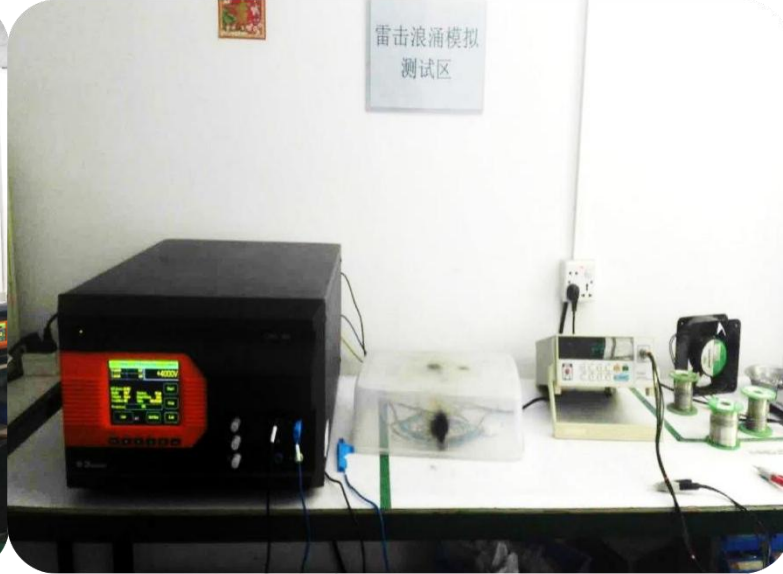

企业资质 Certificate Certification



客户至上、精诚合作、开拓创新、持续提升
"customer first, sincere cooperation, continuous improvement and innovation"

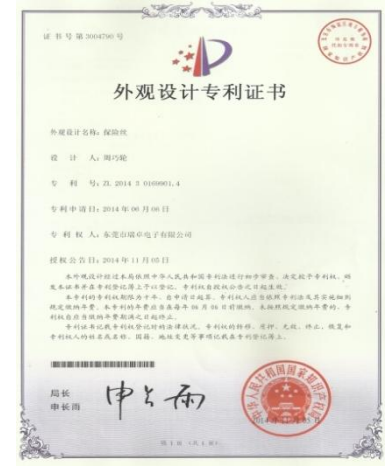
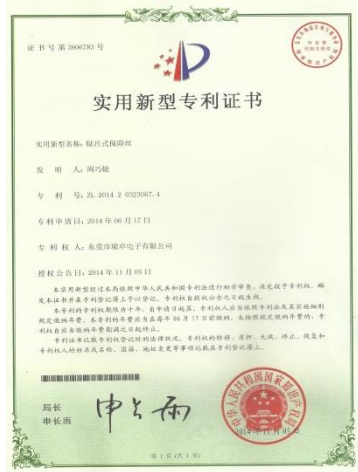

合作伙伴 partners



THANKS

谢谢观看

junkai.chen



0086 13602347376



feng@aolittel-china.com



<http://www.aolittel-china.com>